

Exxon Valdez Oil Spill
Restoration Project Annual Report

Little Waterfall Creek Barrier Bypass Improvement:
Pink (*Oncorhynchus gorbuscha*) and Coho Salmon (*Oncorhynchus kisutch*)
Habitat Enhancement

Restoration Project 95139A1
Annual Report

This annual report has been prepared for peer review as part of the *Exxon Valdez* Oil Spill Trustee Council restoration program for the purpose of assessing project progress. Peer review comments have not been addressed in this annual report.

Steven G. Honnold

Alaska Department of Fish and Game
Commercial Fisheries Management and Development Division
211 Mission Road
Kodiak, Alaska 99615

April 1996

Little Waterfall Creek Barrier Bypass Improvement:
Pink (*Oncorhynchus gorbuscha*) and Coho Salmon (*Oncorhynchus kisutch*)
Habitat Enhancement

Restoration Project 95139A1
Annual Report

Study History: The project efforts were initiated in 1994 (Project 94139A1) as a result of surveys (Restoration Study 93063 - Survey And Evaluation Of Instream Habitat And Stock Restoration Techniques For Wild Pink And Chum Salmon) conducted on Kodiak Island which evaluated instream habitat and stock restoration techniques for wild salmon stocks. The emphasis of this evaluation was to improve or develop spawning habitat at systems with barriers to salmon passage which have historically prevented access. Surveys focused on systems which were directly impacted or were located in proximity to areas impacted by the *Exxon Valdez* oil spill with the intent of mitigating for injured spawning habitat. Data collected from these surveys were analyzed, including a cost to benefit analysis to determine the most effective mitigation techniques for Kodiak Island salmon systems. As result of these surveys, the *Exxon Valdez* Oil Spill Trustee Council selected Little Waterfall Creek as a site for spawning habitat mitigation. An annual report was not required for FY 94, since bypass modifications (construction) were delayed until FY 95. The project was continued under Restoration Project 95139A1, the subject of this annual report.

Abstract: In FY95, pre-construction pink (*Oncorhynchus gorbuscha*) and coho salmon (*Oncorhynchus kisutch*) production parameters were assessed, final engineering surveys completed, and design for bypass improvements finalized. In addition, engineering documents were completed for the contract bidding process, and the contract was awarded to SeaCoast Construction. Construction was scheduled to begin in July, and be completed near the end of the fiscal year, but was delayed due to high water events that prevented work. Thus, construction did not begin until FY 96, and was completed in November. This work is expected to facilitate increased spawning habitat use by pink and coho salmon, thus will increase salmon production to optimum levels in ensuing years. Since encumbered FY 95 funds were used for the construction work in FY 96, the results are included in this report.

Key Words: Afognak Island, barrier bypass, coho salmon, *Exxon Valdez* oil spill, Kodiak Island, *Oncorhynchus gorbuscha*, *Oncorhynchus kisutch*, pink salmon, spawning habitat.

Project Data: *Description of data* - Little Waterfall Creek pink and coho salmon escapement (1968-1996); preemergent sampling results (1982-1997); minnow trapping results (1995-1996). *Format* - Excel tables; text summary of results in Word. *Custodian* - Steve Honnold, Alaska Department of Fish and Game, Commercial Fisheries and Management Division, Kodiak. *Availability* - Available upon request for cost of duplication.

Citation:

Honnold, S.G. 1996. Little Waterfall Creek barrier bypass improvement: Pink (*Oncorhynchus gorbuscha*) and coho salmon (*Oncorhynchus kisutch*) habitat enhancement, *Exxon Valdez* Oil Spill Restoration Project Annual Report (Restoration Project 95139A1), Alaska Department of Fish Game, Commercial Fisheries Management and Development Division, Kodiak, Alaska.

TABLE OF CONTENTS

	<u>Page</u>
STUDY HISTORY/ABSTRACT/KEY WORDS/PROJECT DATA/CITATION.....	i
LIST OF TABLES.....	iv
LIST OF FIGURES.....	v
LIST OF APPENDICES.....	vi
EXECUTIVE SUMMARY.....	1
Introduction.....	1
Methods.....	1
Results and Discussion.....	2
INTRODUCTION.....	3
OBJECTIVES.....	6
METHODS.....	6
RESULTS.....	9
DISCUSSION.....	14
CONCLUSIONS.....	18
ACKNOWLEDGMENTS.....	19
LITERATURE CITED.....	20
FIGURES.....	24
APPENDICES.....	39

LIST OF TABLES

<u>Table</u>	<u>Page</u>
1. Spawner density, fecundity, survivals and exploitation rates used as planning assumptions to forecast pink and coho salmon production benefits for Little Waterfall Restoration project.....	5
2. Little Waterfall Creek pink salmon pre-emergent fry sampling 1982-1994.....	11
3. Little Waterfall Creek minnow trapping results, 1995	11
4. Pink and coho salmon escarpment estimates for Little Waterfall Creek, 1968-1995.....	13

LIST OF FIGURES

<u>Figure</u>		<u>Page</u>
1.	Location of 1989 oiled areas and salmon restoration/mitigation systems	25
2.	Afognak District of the Kodiak Management Area, 1994	26
3.	Location of operational fish passes on Afognak Island	27
4.	Location of bypasses (fishpasses), upstream spawning habitat, and minnow trapping sites at Little Waterfall Creek	28
5.	Design of present barrier bypass at 7.9 meter falls and recommended modifications to improve salmon passage	29
6.	Photographs of Little Waterfall Creek barrier bypass prior to modifications.....	30
7.	Little Waterfall Creek falls #3 steppass improvements	31
8.	Photograph of Little Waterfall Creek barrier bypass modification to reduce gradient and improve resting areas	37
9.	Modified barrier bypass at Little Waterfall Creek showing additional resting pools, and staggered steppass sections.....	38

LIST OF APPENDICES

<u>Appendix</u>	<u>Page</u>
1. Invitation for bids.....	40
2. Abstract presented at 1995 Restoration Workshop.....	42
3. Reviewers comments on Project 95139A-1 (Salmon Instream Habitat and Stock Restoration - Little Waterfall Barrier Bypass Improvement)	43
4. Response to peer review of FY 96 Detailed Project Description for Little Waterfall Barrier bypass Improvement.....	45

EXECUTIVE SUMMARY

Introduction

This report describes the progress of restoration activities at Little Waterfall Creek which were intended to provide for replacement of lost salmon spawning habitat and harvest opportunities due to impacts from the *Exxon Valdez* oil spill. The oil spill severely restricted commercial salmon fishing in most locations near Afognak and Kodiak Islands, impacting local economies. This project resulted from feasibility studies in the affected areas which identified salmon systems with spawning habitat not fully utilized due to barriers to migration. Little Waterfall Creek was selected for restoration, focusing on correcting limitations to an existing barrier bypass, and providing access for pink and coho salmon to ~80% of the system's spawning habitat.

Little Waterfall Creek, located on northern Afognak Island has historically been a significant pink salmon producer since the installation of three bypass structures allowed access to previously inaccessible spawning habitat. The largest bypass, however, has not performed as expected and much of the habitat upstream was not utilized by pink salmon (only 19% of the average run from 1981-1995). Coho salmon escapements are not well documented, however, few (47 of the 95 total escapement in 1994) have been observed upstream of this bypass. Juvenile production information available (preemergent fry indices) indicated poor production upstream of the bypass, likely due to underutilization of spawning habitat but also influenced by poor egg survival.

The primary focus of this project was to improve the design of the bypass which is limiting access to upstream spawning habitat. In addition, adult and juvenile pink and coho salmon production data, necessary to assess pre- and post- project affects were assessed, including summation of data previously collected as result of ADF&G supplementation activity.

Methods

Engineering surveys determined that the deficiencies of the bypass included too steep of a grade (27%), insufficient number and placement of resting pools and excessive water velocity. Options for reduction of grade, adding resting pools, and decreasing water velocity were then addressed. In 1994, preemergent fry sampling was conducted in sites upstream and downstream of the bypass to determine a relative index of fry abundance. In addition, in 1995, minnow trapping was conducted to assess relative abundance of juvenile coho salmon rearing in the creek at similar upstream and downstream habitats. Pink salmon escapement abundance and distribution has been documented in Little Waterfall Creek for most years since 1968 while coho salmon escapements and system distribution has been sporadic, however, were more completely assessed in 1994. In 1995, final design and specifications were completed to improve the bypass with invitations for bids submitted and a contract awarded to SeaCoast Construction Company.

Construction was delayed until FY 96, thus post project assessment of adult and juvenile salmon production has not been undertaken.

Results and Discussion

A design was developed to modify the lower section (60') section of bypass including reduction of the grade to 17%, adding two aluminum resting pools, converting the entrance pool to a resting pool, adding a downstream ~7 m (20') section of 20% grade Alaska steppass and an aluminum entrance tank. The design also included steppass staggered sections at entry and exit points from the resting pools to decrease water velocity in the bypass. Lastly, the design recommended modifying the grade of the upper 7 m (20') section of steppass to 19%.

The completed modifications (in November 1995) provide slopes within the recommended specifications for pink and coho salmon bypass use, at 20% or less, for all sections, compared to 27% prior to the project. Water velocity is expected to be stable in the steppass runs with resting pool velocities greatly reduced, as a result of staggered steppass runs. The addition of two resting pools and modification of the previous entrance tank into an additional resting pool is expected to increase fish endurance and allow steady movement through the bypass.

Pre-emergent sampling at Little Waterfall Creek indicated higher abundance of pink salmon fry in habitat downstream (68%) of the largest barrier falls compared to upstream habitat (32%) in 1994. Previous years data were similar, however, for several years no pink fry were captured in upper habitat. Fry per square meter indices show similar distribution trends, however, the overall system index has declined by eight-fold, with the lowest estimate occurring in 1994 (77.9 fry/m²). The distribution in 1994 was higher in upper (39.5 fry/m²) habitat than lower (37.4 fry/m²) habitat which has declined by fifteen-fold since 1982. The decline of preemergent fry may be related to the high density of spawners in the lower habitat. However, Kodiak pink salmon systems are highly influenced by environmental conditions, thus seasonal fluctuations in stream hydrology at Little Waterfall Creek such as frequent freshet events likely affects egg-to fry survivals. Thus, the decline of fry indices in the downstream habitat, may be influenced by both spawner density and environmental conditions. Coho fry have not been captured in any years pre-emergent samples, however, were captured while minnow trapping in 1995 with catch per unit effort (CPUE) similar for both upstream (0.18 catch per unit effort) and downstream (0.15 catch per unit effort) habitat. The absence of pre-emergent coho salmon fry is likely a result of low escapements and sampling location and frequency.

In 1994, Little Waterfall Creek escapement surveys documented 47 (49%), of the 95 coho salmon counted, distributed upstream of the third barrier falls. The largest recorded coho salmon count prior to this project was 65 (1984), with a mean count from 1981-1995 of 26. A larger proportion (60%) of coho salmon have migrated to upstream habitat by way of the bypass compared to pink salmon (19%), however, additional escapement distribution information is required to further assess coho salmon trends. Prior to completion of the three

barrier bypasses (1968-1980), pink salmon escapement averaged 5,179 with none observed upstream of the third barrier. The post-bypass escapement (1981-1995) has averaged 60,665, with 11,442 (19%) distributed to upper spawning habitat. Odd year pink salmon escapements to the upper habitat have, generally, been larger than even years and correspond to the system escapement trends. Density likely influences bypass use however, does not appear to explain the variation in upper habitat use for all years which is a probable result of design limitations that inhibit consistent migrations.

Pink and coho salmon returning to Little Waterfall Creek in 1996 and ensuing years are expected to have improved access to the primary spawning habitat upstream (~17,000 m²) of the barrier bypass which is predicted to support 24,000 pink and 2,700 coho salmon. At this seeding level, a harvestable surplus of an additional 24,000 pink and 4,000 coho salmon is expected to be available to fishers. The Little Waterfall coho salmon harvest has been minimal, thus a new harvest opportunity will be afforded. The seeding of spawning habitat by coho salmon at current escapement levels (~100 in 1994) is expected to be slow, until optimum escapement levels are reached. Further evaluation of supplementation techniques such as lake stocking may be necessary to increase coho salmon escapements. Little Waterfall Lake, located upstream of the barrier falls may provide opportunity to increase coho salmon escapements. Rearing habitat, indigenous species interactions, and other supplementation criteria will need to be addressed if this option is considered.

INTRODUCTION

Following the *Exxon Valdez* oil spill (EVOS) in 1989, several beaches on Afognak Island were heavily oiled and remained oiled in 1990 (Willette et al. 1994; Figure 1). Little Waterfall Bay (Little Waterfall Creek drainage - stream number 251-822) was directly impacted by oil (Figure 2). Similar impacts in Prince William Sound (PWS) damaged salmon stocks (Willette et al. 1994).

This project began as result of surveys (Restoration Study 93063) conducted on Kodiak Island which evaluated instream habitat and stock restoration techniques for wild salmon stocks (Willette et al. 1994). The emphasis of this evaluation was to improve or develop spawning habitat at systems with barriers to salmon passage which have historically prevented access. Surveys focused on systems which were directly impacted or were located in proximity to areas impacted by the EVOS with the intent of mitigating for injured spawning habitat (Figure 1). Data collected from these surveys were analyzed, including a cost to benefit analysis (Hartman and Richardson 1993), to determine the most effective mitigation techniques for Kodiak Island salmon systems. As result of these surveys, the *Exxon Valdez* Oil Spill Trustee Council selected Little Waterfall Creek as a site for spawning habitat mitigation.

Barrier bypass (fish ladders) projects have been used extensively on Afognak Island (Figure 3) to restore and enhance sockeye (*Oncorhynchus nerka*), coho (*O. kisutch*) and pink salmon (*O.*

gorbuscha) runs (Honnold 1991; Honnold and Edmundson 1993 and Edmundson et al. 1994). For example, the Laura Lake sockeye and coho salmon runs were initially started, and currently sustained, by two bypasses which enable spawner access to underutilized habitat (Honnold and Edmundson 1993). Similarly, pink salmon production at Little Waterfall has been significantly improved through bypasses and increased spawning habitat use (Honnold 1991).

Three barriers in Little Waterfall Creek have been bypassed with structures allowing increased pink and coho salmon passage to previously unused spawning habitat (Edmundson et al. 1994; Figure 4). Pink salmon escapements at Little Waterfall have averaged 39,600 from 1968-1995, with a pre-bypass (1968-1980) average of 5,200 compared to a post-bypass (1981-1995) average of 60,600 (ADF&G unpublished data). Although the system has benefited from the installation of the barrier bypasses, as indicated by the increased pink salmon escapement, the largest barrier bypass structure has not operated efficiently and has impeded salmon passage into the largest portion of spawning habitat (Willette et al. 1994). Since the installation of this bypass, pink salmon escapement to upstream habitat has averaged 11,400. Coho salmon escapement data is incomplete due to enumeration deficiencies (ADF&G unpublished data), however, foot survey counts have ranged from no salmon (several years from 1980 -1993) to 95 (1994). Juvenile production data parallels the adult escapement data with pink fry abundance indices less upstream of the bypass (0.54 fry/m² in 1986; 95.5 fry/m² in 1992) compared to downstream (338.1 fry/m² in 1986; 224.9 fry per m² in 1992). Coho fry have not been identified during any pre-emergent sampling efforts. However, coho fry were observed rearing above (0.18 catch per unit effort) and below (0.15 catch per unit effort) the barrier as indicated by minnow trapping in 1995 (ADF&G unpublished data).

Barrier height, the quality and quantity of spawning habitat above barriers, and the degree of utilization of available spawning habitat significantly affects the efficiency and cost effectiveness of barrier bypasses (Willette et al. 1994). Habitat utilization rates are often considerably less than estimated capacity (McDaniel 1981). Previous evaluation of the habitat above the bypass, using methods as described by Olsen and Wenger (1991) characterized the useable habitat (Chambers et al. 1955) comprising approximately 80% (~17,000 m²) of the total stream habitat (Willette et al. 1994). Using a 1:1 sex ratio, and an optimum female density for pink and coho salmon of 0.7/m² (Heard 1978) and 0.08/m² (Sheng et al. 1990), respectively, approximately 24,000 pink and 2,700 coho salmon can be supported by the available spawning habitat upstream of the bypass. At optimum colonization levels, resultant production is estimated to provide a harvestable surplus of approximately 24,000 pink salmon (Willette et al. 1994; Table 1). Originally, coho salmon production at full seeding of the upstream habitat was estimated to provide ~ 15,000 fish for harvest (Willette et al. 1994). However, egg-to-smolt survival assumptions (7.4%) were derived from sockeye salmon survival data (Honnold and Edmundson 1993). Survival of stream-rearing juvenile coho salmon (1-2%) is much less than that of lake-rearing sockeye (Bradford 1994; Table 1). This lower survival may be related to their aggressive territorial behavior and may result in exclusion of rearing opportunities. Thus, coho production as a result of improved access to upper spawning habitat is revised to ~5,400, of which ~3,000 would be harvested. The original cost to benefit data indicated that this project would have long

term benefits greater than costs of production (Hartman and Richardson 1993). Lower coho salmon survival, however, would decrease the cost to benefit ratio but would still, likely, provide future benefits in excess of project costs.

Table 1. Spawner density, fecundity, survivals and exploitation rates used as planning assumptions to forecast pink and coho salmon production benefits for Little Waterfall Restoration project.

Parameter	Mean	Source (Area)
<u>Pink Salmon</u>		
Optimum female density (#/sq.m)	0.7	Heard (1978)
Average fecundity	1858	PWS(PWS aquaculture assoc. 1991)
Egg-fry survival (%)	6.4	SE Alaska (unpublished ADF&G data)
Marine survival rate (%)	3.1	Alaska (Sharr et al. 1993)
Exploitation rate (%)	54	Kodiak (unpublished ADF&G data)
<u>Coho Salmon</u>		
Optimum female density (#/sq.m)	0.08	Sheng et al (1990)
Average fecundity	4835	Alaska (ADF&G unpublished data)
Egg-smolt survival (%)	2.0	Bradford (1994)
Marine survival rate (%)	4.1	Washington, California (Willette et al 1994)
Exploitation rate (%)	75	Chapman (1986)

The result of an evaluation of the design and operation of the largest bypass structure determined several deficiencies, impacting salmon passage (Willette et al. 1994). The grade of the bypass (27%) was considered too steep (Bruce McCurtain, ADF&G, personal communication). For example, a slope of 22% or less is recommended for sockeye salmon when resting pools (similar to those at Little Waterfall) are employed (Blackett 1987). Pink salmon, a less vigorous fish, may require even less slope (Honnold 1991). Thus, the existing data indicated that the gradient of this bypass should be reduced by modifying the existing concrete resting tanks and extending the lower portion of the bypass, as well as adding two new tanks for improved resting opportunity (Honnold 1995; Figure 5).

In 1994 (FY 94), pre-construction production parameters were assessed, including pink and coho salmon escapements and egg-to-fry abundance indices, engineering surveys were completed, and the initial design for bypass improvements developed (Honnold 1995).

Similarly, in 1995 (FY 95), additional escapement and juvenile production data were collected, including initial coho stream rearing information, final engineering documents were completed for the contract bidding process, and a contract was awarded to SeaCoast Construction (Honnold 1996). Construction, however, scheduled to begin in July 1995, and be completed by September, was delayed due to poor work conditions as result of high water events. Thus, construction did not begin until October (FY 96), and was completed in November 1995. The delay in construction prevented evaluation of the bypass since annual Little Waterfall Creek salmon runs were complete by mid-October.

OBJECTIVES

- 1). Develop the most effective methodology to achieve the required barrier bypass improvement and acquire the appropriate permits.
- 2). Determine pre-construction juvenile salmon production parameters, including egg-to-fry survival and rearing relative abundance.
- 3). Delineate pre-construction coho spawning habitat usage.
- 4). Facilitate bypass improvement by awarding contract for construction, and supervising implementation.
- 5). Evaluate the success of the project by determining salmon spawning numbers and juvenile salmon relative abundance in habitat upstream of the improved bypass.
- 6). Provide necessary documentation of project progress and results.

METHODS

- 1). Develop the most effective methodology to achieve the required barrier bypass improvement and acquire the appropriate permits.**

Surveys were conducted as part of Restoration Project 93063 to develop a design to improve the most upstream barrier bypass at Little Waterfall Creek (Willette et al. 1994; Figure 6). The initial design determined the necessity of modifying the existing resting pools and adding on additional sections of steepass to lower the grade from 27% to 20-25% (Figure 5). The lower grade selected was based on observed salmon performance at Frazer Lake fishpass (Blackett 1987) and at the downstream bypasses at Little Waterfall Creek, as well as other pink salmon systems on Afognak Island (Honnold 1991). Resting areas, water velocity, and other hydrological parameters were considered (Bruce McCurtain, ADF&G, Anchorage, personal communication). Final engineering data were collected in FY95 for development of a specific

design to achieve the required barrier bypass improvement. This data included as-built elevations, existing bypass specifications, and photographs. Blueline drawings were developed outlining modifications to the lower ~20 meter (60') section of bypass. The FY 95 funding level was determined to be only sufficient to complete work on this section of the bypass. Alternate blueline drawings were also completed specifying modification to the upper ~7 meter (20') section of bypass. To assure the success of the project it was deemed prudent to incorporate the alternative plan into the overall modification schedule. Thus, additional funds were requested for FY 95 to enable this construction to proceed.

Lastly, land use approval was requested from Afognak Joint Ventures, and ADF&G habitat permits were reviewed for compliance.

2). Determine pre-construction juvenile salmon production parameters, including egg-to-fry survival and rearing relative abundance.

In 1994, prior to fry emergence, spawning redds downstream and upstream of the barrier were sampled for a relative index of fry abundance (Donnelly 1983; Swanton et al. 1993) and egg-to-fry survival. Ten redds, in both locations, were sampled as described by White (1980; 1986) to capture eggs and fry and enumerate by species (Swanton et al. 1993; White 1988; McNeil 1964). This data collection was intended to assess baseline parameters prior to bypass improvement. , Analysis-of-variance (ANOVA) or analysis-of-covariance (ANOCOVA) will be used once sufficient data is collected after bypass improvement completion to test for pre- and post- bypass improvement differences in emergent fry indices and egg-to-fry survivals, depending on which statistical method is appropriate (Ivan Vining, ADF&G, Kodiak, personal communication).

The relative abundance (catch per unit effort) of juvenile coho salmon rearing downstream and upstream of the barrier was assessed in 1995. Sampling locations (Figure 4) were established in 1995 with two baited minnow traps (Gray et al. 1984; Kyle 1990) set once a month from June through August at each site. All juvenile fish captured after a ~ 24 hour trapping period were enumerated by species and released. Juvenile coho salmon catch per unit effort (CPUE) was calculated for each trapping period for upstream of bypass and downstream of bypass comparison. Again, once sufficient data is collected post bypass construction, ANOVA or ANOCOVA will be used to test for pre- and post- bypass improvement differences in coho fry CPUE, depending on which statistical method is appropriate (Ivan Vining, ADF&G, Kodiak, personal communication).

3). Delineate pre-construction coho spawning habitat usage.

Pre-construction coho spawning habitat usage was assessed in 1994 by conducting foot surveys of Little Waterfall Creek from 19 August through 19 September. Peak live counts were used to estimate coho salmon escapement in the system (Bruce Barrett, ADF&G, Kodiak, personal communication). The estimates were differentiated by habitat upstream and downstream of the barrier bypass. The documentation of pink salmon spawning habitat usage was completed

previously as part of ADF&G annual enhancement monitoring (Honnold 1996). Historical trends of pink salmon escapement in the Little Waterfall system will be summarized in this report. Analysis of variance (ANOVA) or covariance (ANOCOVA) will be used once post project data is available to test for pre and post bypass improvement differences in indexed escapements, depending on which statistical method is appropriate (Ivan Vining, ADF&G, Kodiak, personal communication). In addition, pink salmon escapement variability (run strength; odd/even year differences) will be accounted for by comparing proportions of spawners upstream and downstream of the bypass before and after the improvements. Statistical analysis of this comparison will be defined once data is available.

4). Facilitate bypass improvement by awarding contract for construction, and supervising implementation.

The contract documents and specifications to modify the existing bypass at the third upstream barrier were completed in March 1995. The invitation for bids for the construction contract was submitted by the ADF&G, Division of Administration on April 17, 1995 (Appendix 1). Sealed bids for furnishing labor, equipment and materials and to perform all work for the project were invited and opened publicly at ADF&G in Juneau on 02 June 1995. SeaCoast Construction Company, Anchorage, Alaska was awarded the construction contract and submitted a "schedule of values," describing itemized costs, and a construction progress schedule to ADF&G engineering staff on 17 July 1995. The time period of completion of construction was 120 days upon awarding of the contract. In August, 1995 the contractor informed the ADF&G that the projected schedule could not be met due to logistical delays. Thus, a pre-construction meeting was held on 11 September in Anchorage at the ADF&G office to make alternate plans to complete the project prior to deteriorating fall weather. As a result of this meeting, the contract time was extended for 30 calendar days, with a completion date of 17 November 1995. Also, the principal investigator was assigned project inspection duties. These duties included: 1) checking the contractor's performance for compliance with the technical specifications, drawings, work schedules and Labor Standards of the contract; 2) advising the contractor by issuing directives about any deviations from the contract; 3) reporting to the Contracting Officers Representative (COR) any refusal or failure by the contractor to comply with such contract provisions; and 4) keep progress reports and an official diary about all actions, and developments during the contract period.

Although the construction was not undertaken until FY 96, this document will report on the result of the improvements to the bypass since funds were allocated for the work in FY 95.

5). Evaluate the success of the project by determining salmon spawning numbers and juvenile salmon relative abundance in habitat upstream of the improved bypass.

Since construction was delayed until FY 96, post project salmon production parameters were not assessed in FY 95. However, post-project salmon spawning habitat usage and juvenile

salmon relative abundance in habitat upstream of the improved bypass will be determined in the same manner as previously described.

6). Provide necessary documentation of project progress and results.

The necessary documentation of project progress and results as outlined by the Trustee Council included presenting a project progress report at the annual Restoration Workshop, and attending the Supplementation Workshop sponsored by the Trustee Council in January 1995, and providing requested information in response to peer review comments.

RESULTS

1). Develop the most effective methodology to achieve the required barrier bypass improvement and acquire the appropriate permits.

An engineering survey was conducted on 24 August 1994 to assess limitations to salmon passage at the most upstream barrier bypass. This survey provided as built dimensions and identified specific improvements in design to decrease slope and flow (Figure 5). The existing bypass was composed of a concrete entrance pool (5' x 5' x 5'), a ~20 m (60') run of Denil-type (Ziemer 1962; 1965) Alaska steppass (Honnold 1991) at 26.5% grade, a concrete resting pool (5' x 5' x 5'), a ~7 m (20') run of steppass at 27% grade, another concrete resting pool (5' x 5' x 5' with 7' base length), and open concrete channel at a 4% grade (Figure 6). The runs of steppass entered and exited the entrance and resting pools without staggering.

As result of the survey, blue line drawings were developed outlining proposed modifications to the lower section (60') section of bypass (Figure 7). These modifications included reduction of the grade to 17% , adding two aluminum resting pools (5' x 6'), converting the entrance pool to a resting pool and elevating to accommodate the decreased grade, the addition of a ~7 m (20') section of Alaska steppass (20% grade) downstream of the original entrance tank and the addition of an aluminum (4' x 4') entrance tank. The steppass sections would be staggered upon entry and exit to and from the resting pools to decrease water velocity in the bypass.

The cost estimate generated to complete the modifications to the lower run of the bypass was ~ \$82,000. The allocated funding for the construction was \$80,000. Since, a contingency of 10% was included, this funding level appeared adequate to complete the work. However, the improvements did not address the upper run of the bypass which was also at a grade (27%) which is considered too steep for salmon passage (Blackett 1987; Honnold 1991). Thus, a request was made to engineering staff to prepare an alternate plan to address this section of the bypass. Blue line drawings were completed (Figure 7) which proposed modifying the grade of the 7 m (20') steppass to 19% by rock excavation, removing the downstream wall of the original "middle" resting pool, pouring a new concrete wall, and reinstalling the steppass between the "middle" and "upper" resting pools at the desired slope. The estimated cost for this

modification was ~\$12,000. Additional funds were requested to accommodate this alternate plan, which was approved by the Trustee Council in August 1995.

On 15 June 1995, land use approval was requested by ADF&G for construction on the bypass at Little Waterfall Creek. Afognak Joint Ventures approved this request on 16 June 1995. The agreement allowed use of land in vicinity of the established ADF&G camp for temporary construction staging, housing, and modification work. In addition, fish habitat permit (FG 95-II-0307) previously acquired to complete barrier bypass modification was reviewed for compliance. The primary stipulations of the permit were: 1) streambank disturbance and 2) prevention of fish mortality caused by delay in migration. The construction did not result in streambank disturbance. Also, since the construction was delayed until November 1995, salmon migration delays did not occur.

2). Determine pre-construction juvenile salmon production parameters, including egg-to-fry survival and rearing relative abundance.

Little Waterfall Creek was sampled on 07 April 1994 to estimate pre-emergent salmon fry relative abundance (Table 2). Ten samples each were collected at sites upstream and downstream of the third most upstream barrier falls (Figure 4). In 1995, high flows and poor weather prevented sampling. Prior to this project, samples were collected at both upstream and downstream locations when time permitted (1982, 1986, 1987, and 1992). In 1994, at downstream sample sites, 316 (68%) pink salmon fry were captured compared to 147 (32%) upstream of the barrier falls. The distribution of pink salmon fry captured downstream (71%) and upstream (29%) of the barrier was similar in 1992, however, in 1982 (0), 1986 (2) and 1987 (0), few fry were captured above the barrier. Estimates of fry per square meter have shown similar trends, except in 1994, when the indexed abundance at upstream sites was 39.5 fry/m² compared to 37.4 fry/m² at downstream sampling sites. The abundance estimate in 1994 (77.9 fry/m²) for both locations combined was the lowest for all years. Coho salmon have not been captured at any sample locations.

Table 2. Little Waterfall Creek pink salmon pre-emergent fry sampling 1982 - 1994.

Year	Date	# Digs	% Digs w/fry	Number of Pink Fry ^a				Indexed # of Pink Fry ^b		Total Indexed # Pink Fry
				U.stream	%	D. stream	%	U.stream	D. stream	
1982	6-Apr	20	50	0	0.0	2177	100.0	0	585.61	585.61
1986	25-Mar	20	55	2	0.2	1259	99.8	0.54	338.10	338.67
1987	1-Apr	20	80	0	0.0	458	100.0	0	246.40	246.40
1992	28-Mar	20	100	353	29.2	856	70.8	95.5	224.90	320.40
1994	7-Apr	20	55	147	31.7	316	68.3	39.5	37.40	77.90

^a Actual number of pink fry enumerated from all digs; coho fry were not captured in any digs.

^b Estimated number of pink fry per square meters.

Minnow trapping was conducted 30 June, 07 July and 23 August 1995 to assess the relative abundance of juvenile coho salmon rearing in Little Waterfall Creek. Twelve coho (0.18 CPUE) salmon fry were caught upstream of the barrier compared to 10 captured (0.15 CPUE) at the downstream trapping location during 68.5 hours of sampling (Table 3).

Table 3. Little Waterfall Creek minnow trapping results, 1995.

Date	Location ^a	# Traps	Hours Fished	Catch			
				Coho Fry	CPUE ^b	Stickleback	DV char
30-Jun	Upstream	2	20.5	4	0.20	0	0
	Downstream	2	20.5	9	0.44	2	0
7-Jul	Upstream	2	24	5	0.21	0	2
	Downstream	2	24	1	0.04	1	0
23-Aug	Upstream	2	24	3	0.13	0	0
	Downstream	2	24	0	0.00	0	0
Totals:	Upstream	6	68.5	12	0.18	0	2
	Downstream	6	68.5	10	0.15	3	0
Mean:	Upstream	2	22.8	4.0	0.18	0	0.7
	Downstream	2	22.8	3.3	0.15	1	0

^a Upstream and downstream of third most upstream barrier falls.

^b Catch-per-unit-effort.

3). Delineate pre-construction coho spawning habitat usage.

A total of 95 live coho salmon were enumerated in Little Waterfall Creek on 19 September 1994, with 47 (49%) distributed upstream of the third barrier falls (Table 4). High water events prevented coho escapement surveys in 1993 and 1995. ADF&G has previously documented coho usage, associated with pink salmon enhancement activities in the system. Counts, however, have been sporadic and often incomplete due to insufficient funding and weather constraints. The largest recorded coho salmon count prior to this project was 65 (1984), with a mean count from 1981-1995 of 26 fish. Stream distribution was recorded in 1990 and 1991 when 11 (61%) and 22 (71%) coho were observed upstream of the barrier, respectively. Coho were also observed in the upstream areas in 1989 (22) and 1992 (34), however, overall system escapement is unavailable for those years.

Pink salmon escapement has been documented from 1968 through 1995 (Table 4). Prior to completion of the three barrier bypasses (1968-1980), pink salmon escapement averaged 5,179 with no fish observed upstream of the third barrier. The post bypass escapement (1981-1995) has averaged 60,665, with 11,442 (19%) distributed to upper spawning habitat. In recent years (1990's) pink salmon distribution to the upper reaches has varied considerably, with an escapement of 45,000 (45% of total) in 1993 compared to 6,500 and 8,300 in 1994 and 1995, respectively. Odd year pink salmon escapements to the upper habitat have, generally, been larger than even years and correspond to the entire system escapement trends.

Table 4. Pink and coho salmon escapement estimates for Little Waterfall Creek, 1968-1995.

Year	Pink Salmon			Coho Salmon		
	Total ^a	Upstream ^b	%	Total ^a	Upstream ^b	%
1968	500	0	0	nd	nd	nd
1969	nd	nd	nd	nd	nd	nd
1970	2,000	0	0	nd	nd	nd
1971	nd	nd	nd	nd	nd	nd
1972	499	0	0	nd	nd	nd
1973	nd	nd	nd	nd	nd	nd
1974	6	0	0	nd	nd	nd
1975	7,000	0	0	nd	nd	nd
1976	5,000	0	0	nd	nd	nd
1977	nd	nd	nd	nd	nd	nd
1978	3,580	0	0	nd	nd	nd
1979 ^c	7,150	0	0	nd	nd	nd
1980	15,700	0	0	nd	nd	nd
1981	61,193	1,100	2	3	nd	nd
1982	47,500	0	0	15	nd	nd
1983	21,700	1,600	7	5	nd	nd
1984	40,000	10,400	26	65	nd	nd
1985	119,200	19,800	17	0	nd	nd
1986	48,400	nd	nd	nd	nd	nd
1987	29,100	nd	nd	1	nd	nd
1988	49,680	nd	nd	nd	nd	nd
1989	117,200	19,500	17	nd	22	nd
1990	47,000	3,100	7	18	11	61
1991	115,000	16,000	14	31	22	71
1992	43,000	6,000	14	nd	34	nd
1993	111,000	45,000	41	nd	nd	nd
1994	23,000	6,500	28	95	47	49
1995	37,000	8,300	22	nd	nd	nd
Mean:	39,642	6,538	16	26	34	61
Mean 68-80:	5,179	0	0	nd	nd	nd
Mean 81-95:	60,665	11,442	19	26	34	61

^a First two barriers bypassed with fish passes in 1979; third bypassed in 1980.

^b Foot or aerial survey estimates - 1968-76, 1981, 1988-89, 1993-1995; weir counts - 1982-87, 1990-92.

^c Foot survey estimates upstream of third barrier bypass.

nd = no data.

4). Facilitate bypass improvement by awarding contract for construction, and supervising implementation.

A construction contract (IHC 95-001) was awarded to SeaCoast Construction on 02 June 1995, based on the final specifications (Figure 7) for bypass modifications. The contractor submitted a "schedule of values" and the anticipated construction progress schedule on 17 July 1995. The contract amount was \$72,513 and construction was estimated to be complete in 14 days upon mobilization and camp set up. Logistical delays, however, resulted in a revised schedule and extension of the contract for an additional 30 days. In addition, two "change orders" were included to accommodate installation of a cover for the existing resting pool, and aluminum channel top-ties for steeppasses furnished by ADF&G. This resulted in an adjustment of the contract amount to \$74,168.

The contractor and construction crew arrived on site at Little Waterfall Creek on 23 October 1995. During the construction period, the project was inspected once on 01 November, however, the majority of the work was incomplete at that time due to high water conditions. The requirements of the contract, however, were being complied with at that time and all modifications were later complete by 17 November. On 06 March 1996 the completed bypass was inspected (Figure 8) and found to conform with the approved contract documents and all contract change orders.

5). Evaluate the success of the project by determining salmon spawning numbers and juvenile salmon relative abundance in habitat upstream of the improved bypass.

Post project salmon production parameters were not assessed in FY 95 since the bypass modifications occurred in FY 96 after salmon runs were complete.

6). Provide necessary documentation of project progress and results.

A project progress report was presented at the annual Restoration Workshop on 18 January 1995 (Appendix 2). The project was peer reviewed in 1995 with comments forwarded to the Chief Scientist (Dr. Robert Spies) on 31 March 1995 (Appendix 3). Specific questions were addressed and forwarded to the Trustee Council on 14 June 1995 (Appendix 4).

DISCUSSION

The primary factor that has limited full utilization of spawning habitat upstream of the largest barrier falls at Little Waterfall Creek is inadequate passage through the bypass. The original design of the bypass did not provide proper slope or water velocity conducive to salmon use. Smaller bypasses located downstream of the bypass in question are readily used by pink salmon and have slopes of 20% (Honnold 1991). Similarly, the Portage Creek fishpass with a 13% slope is used without difficulty by pink salmon (Honnold 1991). Other fishway evaluations

indicate that sockeye, coho and chinook pass readily through bypasses with 13%-28.7% slopes (Slatick 1973; Gauley 1960; Gauley and Thomson 1962) , however, fish passage is not improved if slopes are reduced further (Gauly 1960). Antonnikov (1964) recommends a 22-25% slope to assure water discharge sufficient to attract fish to enter a bypass. Similarly, more recent assessment by Blackett (1987) reported that sockeye, as well as chinook salmon ascend the Frazer Lake fishpass (22% slope) without difficulty. Pink salmon, a physically less vigorous fish, appear to need slopes in the 13-20% range, for optimum passage through bypasses. This is supported by the poor use of the exiting upstream bypass (19% passage) which is at 27% slope compared to the downstream bypasses with 20 % slope.

A fishway (bypass) must be designed so that water velocities do not exceed the swimming capabilities of the target species (Ziemer 1965). Larger sockeye, coho and chinook salmon, can withstand high water velocity (13.4-15.8 fps) however, smaller fish of these species may not successfully negotiate similar flows rates (Weaver 1962). In general, salmonids seem to prefer water velocity of approximately eight feet per second (fps) (Antonnikov 1964). For short duration's, velocities of 8 fps are not excessive (Ziemer 1965). Flows should also be sufficient to provide a minimum discharge from the bypass entrance of 3 fps to attract fish and resting areas with velocity not greater than 1 fps are necessary every 10 feet of vertical rise, depending on shape and length (Ziemer 1965). Insufficient number and poor location of resting pools also reduces salmon passage (Bruce A. McCurtain, ADF&G, Anchorage, person communication). Paulik et al (1957) reported that coho salmon are highly susceptible to fatigue in swimming performance tests and concluded that adequate resting facilities are necessary in fishways with water velocities exceeding 1.1 meters per second (3.61 fps) for any considerable distance. Blackett (1987) noted that the resting tanks at Frazer Lake fishpass were beneficial for holding slower or descending salmon without blocking passage of other salmon. It is also necessary to provide consistent flow patterns in bypasses to allow for head increases, and stable water velocity. The design of the Alaska -type fishpass accounts for these head changes with baffles reducing water velocity (Ziemer 1965). The original design of the most upstream bypass at Little Waterfall did not provide adequate water velocities for consistent pink salmon passage. Pink salmon swimming ability has been observed to be poor in the bypass during high flow events. Water velocity appeared to exceed the optimum for larger salmonid species during most conditions, and baffles were not always effective because of the excessive slope. Resting pool water velocity likely exceeded the recommended level (1 fps) due to the long steeppass section runs and pools not being staggered to break up the flow energy. In general, most of the literature does not address the limitations of pink salmon swimming ability with regards to bypass use, instead focusing on other salmonid species. The affected bypass was designed and constructed in the late 1970's when most performance parameters were gleaned from successful Chinook, steelhead, and coho projects.

This project provided for modifications to the bypass to correct deficiencies in slope, water velocity, and number and location of resting pools. Slopes for all sections are now at 20% or less, compared to 27% prior to the project. Water velocity is expected to be stable in the steeppass runs with resting pool velocities greatly reduced, as a result of staggering of

steppass runs. The addition of two resting pools and modification of the previous entrance tank into an additional resting pool, all at the optimum spacing, is expected to increase fish endurance and allow steady movement through the bypass. The outflow at the new entrance pool is also predicted to provide the required attraction for salmon to enter easily. The alternate modification to the steepest, uppermost section of the bypass also reduces slope, velocity and provides resting pool requirements, thus, completes improvements to the entire bypass.

The larger distribution of the pink salmon escapement in habitat downstream of the bypass has resulted in the production of more juvenile pink salmon in downstream habitat compared to upstream habitat as reflected in pre-construction pre-emergent fry data. Little Waterfall Creek often has one of the highest annual indices of pink salmon fry/m² on Afognak Island (Kevin Brennan, ADF&G, Kodiak, personal communication). However, the system index declined by eight-fold from 1982 to 1994 with indices of downstream spawning habitat declining by fifteen-fold. This may reflect habitat degradation due to the uneven distribution of pink salmon that spawn in the system. Approximately 80% of the systems spawning habitat is located upstream of the largest barrier bypass (Honnold 1995), however, average pink salmon distribution to this area has been only 19% of the total escapement. This indicates that 81% of the escapement utilizes only 20% of the spawning habitat. The declining index of pre-emergent fry may be related to the high density of spawners in the lower habitat. Swanton et al (1993) reported no conclusive evidence that the depression of pink salmon indices (fry/m²) for the Kodiak Island systems, overall, was directly caused by high spawner densities as a result of the 1989 overescapements. However, the same study reported that Little Waterfall Creek exhibited the most negative #Sd_{fry}/m² (Standardized Residuals=(1990 fry/m² - historical mean fry/m²)/standard deviation of historical mean fry/m²) of 23 Kodiak streams examined. Previous Kodiak Island studies suggested significant density dependent relationships for pink salmon populations for both egg retention and preemergent fry response (Donnelly 1983; Eggers et al 1991). The relationship between spawner density and resultant fry produced is often highly influenced by environmental conditions for Kodiak pink salmon systems (Charles O. Swanton, ADF&G, Kodiak, personal communication).

Seasonal stream hydrology fluctuations likely affects egg to fry survivals at Little Waterfall Creek since the system is dynamic with frequent freshet events. Thus, the decline of fry/m² indices in the downstream habitat, may be influenced by both spawner density and environmental conditions. Although the overall index of fry/m² in 1994 was the lowest recorded for all years, the upstream habitat (above the largest bypass) index was greater than the downstream index. This change corresponds to the only brood year (1993) that the upper habitat was fully utilized by pink salmon spawners.

The absence of coho salmon fry in pre-emergent samples is not unexpected with the low spawner numbers observed in the system. Additional samples in different locations may be necessary to document emergent coho salmon fry abundance indices.

Coho salmon fry CPUE, a result of minnow trapping, in Little Waterfall Creek was slightly higher in the upstream sample location compared to downstream area. This data is considered minimal, with rearing relative abundance assessed for only one year. Sampling will be expanded in ensuing years to assess catch per unit effort over a longer period (June-September), in additional locations and with increased effort to enable more inclusive analysis.

Coho salmon escapement surveys at Little Waterfall Creek have been limited due to funding and weather constraints, however, pink salmon escapements have been well documented. The escapement distribution to upper habitat indicates a larger proportion (60%) of coho salmon have migrated by way of the bypass compared to pink salmon (19%). The limitations of the bypass, previously discussed, appear to affect pink salmon migrations to a greater extent than coho migration. Coho salmon generally spend more time in fresh water during spawning migration (Donald "Tony" Chatto U.S. Fish and Wildlife Service, Kodiak, personal communication), thus more would be expected to eventually be observed in the upper habitat over time. In 1994 less than half (49%) of the coho observed were upstream of the bypass, which may indicate bypass performance limitations for this species as well. Additional escapement distribution information is required to further assess these trends. The small coho escapement at Little Waterfall Creek, compared to pink salmon, poses difficulty in assessment of bypass limitations. However, bypass modifications would be predicted to assist the migration to upper habitat, since slope and water velocity criteria of the pre-project bypass were at upper limitations for coho salmon.

Pink salmon utilization of spawning habitat at Little Waterfall Creek has been greatly improved as result of the original bypasses, as indicated by a twelve-fold increase (5,000 to 60,000) in the mean escapement post-bypass completion. However, 80% of the spawning habitat is upstream of the largest bypass and has been fully utilized only once (1993) in 15 years. Generally, data indicates variable use of the upper habitat, however, larger escapements (odd year) have frequently resulted in greater utilization of the habitat upstream of the barrier. Thus, the present use of the bypass may be influenced by density.

Fish vigor may be important to Little Waterfall pink salmon movements upstream (Roger Blackett, ADF&G retired, Kodiak, personal communication). Early returning fish, being more vigorous, may migrate through the bypass at greater rates. A tagging study conducted in 1991 supported this theory, in part, when 45.3% of pink salmon tag recoveries from 25 July- 02 August fish tagged at a weir located near salt water at Little Waterfall Creek, were observed in upper habitat (ADF&G unpublished data). Only 21% of fish tagged from 09-16 August were recovered in habitat upstream of the bypass. However, in 1992 when tagging was replicated, only 28% of fish tagged during the early period were recovered upstream of the bypass compared to 19% for later tagging. The escapement in 1991 was 115,000 with 16,000 observed upstream compared to 43,000 and 6,000, respectively in 1992, indicating that density as well as escapement timing may have influenced the tagging results. Density, however, does not appear to explain the variation in upper habitat use for all years. In 1993, when 45,000 (41%) pink salmon were observed upstream, overall escapement was estimated at 111,000, however, in

1984 and 1994, when 26% and 28% of the escapement, respectively, migrated to upstream habitat, the escapement levels were only 40,000 and 23,000, respectively. This indicates that density may contribute to bypass use, but does not solely determine migration variability. Variation in the bypass use is most likely a result of design limitations that inhibit consistent migrations.

The problems identified with the design of the barrier bypass were corrected in 1995. The slopes of each of the steep pass runs are now within the recommended specifications for pink and coho salmon bypass use. Water velocity has also been stabilized, including resting pool additions.

Pink and coho salmon returning to Little Waterfall Creek in 1996 and ensuing years are expected to have improved access to the majority of spawning habitat upstream of the barrier bypass. This habitat (~17,000 m²) is predicted to support 24,000 pink and 2,700 coho salmon (Willette et al 1994). At this seeding level, an additional harvestable surplus of 24,000 pink and 4,000 coho salmon is projected. Pink salmon harvest of Little Waterfall pink salmon has averaged (1982-1995) approximately 50,000 annually (ADF&G unpublished data). Thus, the full utilization of habitat will result in almost 50% more pink salmon for harvest. Coho salmon harvest at Little Waterfall has been minimal, thus new harvest opportunity will be afforded. The seeding of spawning habitat by coho salmon at current escapement levels (~100 in 1994) is expected to be slow. For example, if 100 additional fish reach the upper spawning area, only 800 coho salmon would be predicted to be produced (Table 1). Assuming a 75% exploitation rate, leaves 200 for escapement. This increase would, then be expected to continue slowly until optimum levels are reached in approximately ten years. In ensuing years, it would be prudent to evaluate the utility of further supplementation techniques to increase coho salmon escapements. Several coho supplementation projects undertaken on Afognak Island, have successfully produced returns by way of juvenile lake stocking (Honnold and Clevenger 1995). Little Waterfall Lake, located upstream of the barrier falls may provide similar opportunity to increase coho escapements. Rearing habitat, indigenous species interactions, and other supplementation criteria will need to be addressed if this option is considered.

CONCLUSIONS

Little Waterfall Creek pink salmon have had limited access to upstream spawning habitat, which has resulted in an excess number of spawners distributed in downstream habitat. The insufficient slope, limited number of resting pools and resultant high water velocity of the largest barrier bypass was identified as the primary explanation for poor utilization of upper habitat. Bypasses with slopes of 13-20%, with evenly spaced (one/10 foot rise) resting pools providing flows of 8 fps or less, enable consistent pink salmon passage. Coho salmon have similar requirements, however, can negotiate bypasses with steeper slopes. The pre-project bypass design was insufficient due to slopes of 27%, irregular spaced resting pools and resultant high water velocity, especially during freshet events. This project provided for modifications to correct the original bypass design, including reducing slopes to 20% or less,

and adding three properly spaced staggered resting pools which is expected to stabilize water velocity and improve both pink and coho salmon passage to upper spawning habitat. The juvenile and adult production assessment prior to bypass modification, reflects the poor passage to upper habitat as indicated by low preemergent fry abundance, and spawner distribution. Coho salmon rearing relative abundance was slightly higher in upstream habitat, however, few fish were trapped in either area. Additional sampling is needed to more thoroughly identify abundance trends. The high incidence of over utilization of spawning habitat downstream of the bypass may have decreased pink salmon fry production, however environmental factors most likely also influenced declining fry numbers. The variation in bypass passage by pink salmon indicates that density alone does not explain the years of increased escapement to upstream habitat and is most likely a result of steep pass water velocity in response to season hydrological changes in Little Waterfall Creek. Coho salmon adult and juvenile data is limited, and additional sampling is necessary to determine production trends. With modifications complete to the bypass, full seeding of upstream habitat can potentially provide ~50% more pink salmon for harvest. Coho salmon will also be available to harvest when escapement levels reach optimum levels, however, with the current small run, is not expected to occur in the near-term. Major unanswered questions include: juvenile coho salmon rearing abundance trends, coho salmon escapement and distributions, and how the improved bypass affects salmon passage in ensuing years.

ACKNOWLEDGMENTS

I acknowledge ADF&G personnel Bruce McCurtain and Carol Schneiderhan who collected engineering data and prepared bypass design; SeaCoast Construction personnel who conducted modification work; Kodiak ADF&G personnel Kevin Brennan, Dennis Gretch, Pete Cleary, Mark Kanstiener and Wes Ghormley who collected juvenile and adult production data; Lucinda Neel and Celia Rozen for publication expertise, Kodiak ADF&G personnel Jim McCullough, Ivan Vining and Stephen Schrof for editorial comments, Anchorage ADF&G personnel Bill Hauser, Joe Sullivan and Dan Moore for project management responsibilities, and, finally, the Chief Scientist, Robert Spies and other peer reviewers for project design improvements.

LITERATURE CITED

- Antonnikov, A. 1964. untitled and unpublished report.
- Barrett, B.M., C.O. Swanton, and P.A. Roche. 1990. An estimate of the 1989 Kodiak management area salmon catch, escapement, and run number had there been a normal fishery without the *Exxon Valdez* oil spill. Alaska Department of Fish and Game, Division of Commercial Fisheries, Regional Information Report 4K90-35.
- Blackett, R.F. 1987. Development and performance of an Alaska steep pass fishway for sockeye salmon (*Oncorhynchus nerka*). Canadian Journal of Fisheries and Aquatic Sciences. Vol. 44, No. 1. p. 66-76.
- Bradford, M.J. 1994. Comparative review of Pacific salmon survival rates. Canadian Journal of Fisheries and Aquatic Sciences. Vol. 52: 1327-1338.
- Chambers, J.S., G.H. Allen and R.T. Presley. 1955. Research relating to the study of spawning grounds in natural areas. In W.R. Meehan (ed.) Influence of forest and rangeland management on anadromous fish habitat in the Western United States and Canada. USDA Forest Service. General Technical Report PNW-96.
- Chapman, D.W. 1986. Salmon and steelhead abundance in the Columbia River in the nineteenth century. American Fisheries Society 115:662-670.
- Donnelly, R.F. 1983. Factors affecting the abundance of Kodiak Archipelago pink salmon (*Oncorhynchus gorbuscha*). A dissertation submitted in partial fulfillment of the requirement for the degree of Doctor of Philosophy, University of Washington. 157 p.
- Eggers, D.M., L.R. Peltz, B.G. Bue, and T.M. Willette. 1991. Trends in abundance of hatchery and wild stocks of pink salmon in Cook Inlet, Prince William Sound, and Kodiak, Alaska. Alaska Department of Fish and Game, Division of Commercial Fisheries, Professional Paper 035, Juneau.
- Edmundson, J.A. , S.G. Honnold, and G.B. Kyle. 1994. Trophic responses to juvenile sockeye salmon (*Oncorhynchus nerka*) stocking and nutrient enrichment in barren Little Waterfall lake. Alaska Department of Fish and Game, Regional Information Report No. 5J94-13, Juneau.
- Gauley, J.R. 1960. Effect of fishway slope on rate of passage of salmonids. U.S. Fish and Wildlife Service, Special Scientific Report - Fisheries No. 350, 23 pp.
- Gauley, J.R. and C.S. Thomson. 1963. Further studies on fishway slope and its effect on rate of passage of salmonids. Fishery Bulletin: Vol. 63, No. 1:45-62.

- Gray, P.L., Koerner, J.F., and R.A. Marriott. 1984. The use of minnow traps for evaluating rearing coho salmon (*Oncorhynchus kisutch*), populations and habitat in southeastern Alaska. Alaska Department of Fish and Game, Division of Commercial Fisheries. Informational Leaflet. 70 p.
- Hartman, J.L. and J. Richardson. 1993. Applying cost-benefit analysis to salmon restoration projects studies in the "Restoration Survey" of the EVOS Restoration program. *In: survey and evaluation of instream habitat and stock restoration techniques for wild pink and chum salmon. Exxon Valdez oil spill Restoration Project 93063 final report, Alaska Department of Fish and Game, Habitat and Restoration Division, Anchorage.*
- Heard, W.R. 1978. Probable case of streambed overseeding: 1967 pink salmon (*Oncorhynchus gorbuscha*) spawners and survival of their progeny in Sashin Creek, southeastern Alaska. *Fish Bull.* 76:569-582.
- Honnold, S.G. 1994. Survey and evaluation of instream habitat and stock restoration techniques for wild pink, chum, coho and sockeye salmon Oil Spill Restoration Study 105 - Kodiak Island Component. *In: Survey and evaluation of instream habitat and stock restoration techniques for wild pink and chum salmon. Exxon Valdez Oil Spill Restoration Project 93063 final report, Alaska Department of Fish and Game, Commercial Fisheries Management and Development Division, Anchorage.*
- Honnold, S.G. 1996. Salmon instream habitat and stock restoration - Little Waterfall barrier bypass improvement Detailed Project Description (FY97) to *Exxon Valdez Oil Spill Trustee Council*, 23 p.
- Honnold, S.G. 1995. Salmon instream habitat and stock restoration - Little Waterfall barrier bypass improvement Detailed Project Description (FY 96) to *Exxon Valdez Oil Spill Trustee Council*, 11 p.
- Honnold, S.G. 1991. Assessment and evaluation of the performance of fishpasses located on Afognak Island. Unpublished report. Alaska Department of Fish and Game, Kodiak.
- Honnold, S.G. and C. Clevenger. 1995. Pillar Creek Hatchery annual management plan, 1995. Alaska Department of Fish and Game, Regional Information Report No. 4K95-27, Kodiak.
- Honnold, S.G. and J.A. Edmundson. 1993. Limnological and fisheries assessment of sockeye salmon (*Oncorhynchus nerka*) production in the Laura Lake system. Alaska Department of Fish and Game, FRED Division Report Series 130:55 p.

- Kyle, G.B. 1990. Aspects of the food habits and rearing behavior of underyearling coho salmon (*Oncorhynchus kisutch*) in Bear Lake, Kenai Peninsula, Alaska. Alaska Department of Fish and Game, FRED Division Report Series 105:36 p.
- McDaniel, T.R. 1981. Evaluation of pink salmon (*Oncorhynchus gorbuscha*) fry plants at Seal Bay creek, Afognak Island, Alaska. Alaska Department of Fish and Game Informational Leaflet No. 193, 9 p.
- McNeil, W.J. 1964. A method of measuring mortality of pink salmon eggs and larvae. U.S. Fish and Wildl. Serv., Fish. Bull. 63: 575-588.
- Paulik, G.J., A.C. DeLacy, and E.F. Stacy. 1957. The effect of rest on the swimming performance of fatigued adult silver salmon. Univ. Wash. College Fish. Tech. Rep. 31: 24 p.
- Prince William Sound Aquaculture Association. 1991. Production planning recommendations to the Board. Prince William Sound Aquaculture Association, Cordova, Alaska.
- Olsen, R.A. and M. Wenger. 1991. Cooper Landing Cooperative Project, Stream Habitat Monitoring. USFS Internal Report.
- Schmidt, D.C., K.E. Tarbox, B.M. Barrett, L.K. Brannian, S.R. Carlson, J.A. Edmundson, J.M. Edmundson, S.G. Honnold, B.E. King, G.B. Kyle, P.A. Roche, P. Shields, and C.O. Swanton. 1993. Sockeye salmon overescapement, *Exxon Valdez* Oil Spill State/Federal Natural Resource Damage Assessment Final Report (Fish/Shellfish Study Number 27), Alaska Department of Fish and Game, Commercial Fisheries Management and Development Division, Soldotna, Alaska.
- Sharr, S. , T.M. Willette, C.J. Peckham, D.G. Sharp, J.L. Smith, D.G. Evans, and B.G. Bue. 1993. Coded wire tag studies on PWS salmon. Natural Resource Damage Assessment Fish/Shellfish Study Number 3, Alaska Department of Fish and Game, Cordova.
- Sheng, M.D. , M. Foy, and A.Y. Fedorenko. 1990. Coho salmon enhancement in British Columbia using improved groundwater-fed side channels. Can. Man. Rep. Fish. and Aquat. Sci. no. 2071.
- Slatick, E. 1975. Laboratory evaluation of a denil-type steep pass fishway with various entrance and exit conditions for passage of adult salmonids and American shad. Mar. Fish. Rev. 37(9): 17-26.
- Swanton, C.O., T.J. Dalton, B.M. Barrett, D. Pengilly, K.R. Brennan, and P.A. Nelson. 1993. Effects of pink salmon (*Oncorhynchus gorbuscha*) escapement level on egg retention, preemergent fry, and adult returns to the Kodiak and Chignik management areas caused by

the *Exxon Valdez* Oil Spill State/Federal Natural Resource Damage Assessment Final Report (Fish/Shellfish Study Numbers 7B and 8B), Alaska Department of Fish and Game, Commercial Fisheries Management and Development Division, Kodiak, Alaska.

Weaver, C.R. 1962. Influence of water velocity upon orientation and performance of adult migrating salmonids. *Fish Bull.* Vol. 63, No. 1: 97-118.

White, L.E. 1980. Evaluation of a new planting device for salmon eggs. *Prog. Fish. Cult.* 42:177-180.

White, L.E. 1986. Successful rehabilitation of a sockeye stock utilizing an egg planting device. *Proceedings of the Northwest Fish Culture Conference.* Eugene, Oregon.

White, L.E. 1988. Karluk Lake sockeye salmon investigations: successful rehabilitation of Upper Thumb river sockeye salmon stock. Alaska Department of Fish and Game, FRED Division, Federal Aid in Anadromous Fish Conservation annual report. 27 p.

Willette, T.M., N. Dudiak, and S.G. Honnold. 1994. Survey and evaluation of instream habitat and stock restoration techniques for wild pink and chum salmon. *Exxon Valdez* oil spill Restoration Project 93063 final report, Alaska Department of Fish and Game, Habitat and Restoration Division, Anchorage. 173 p.

Ziemer, G.L. 1962. Steeppass fishway development. Alaska Department of Fish Game Inf. Leaflet. 12: 35 p.

Ziemer, G.L. 1965. Steeppass fishway development. Addenda to Inf. Leaflet. 12. Unpublished manuscript. 5 p. Alaska Department of Fish Game, Juneau, AK 99801.

FIGURES

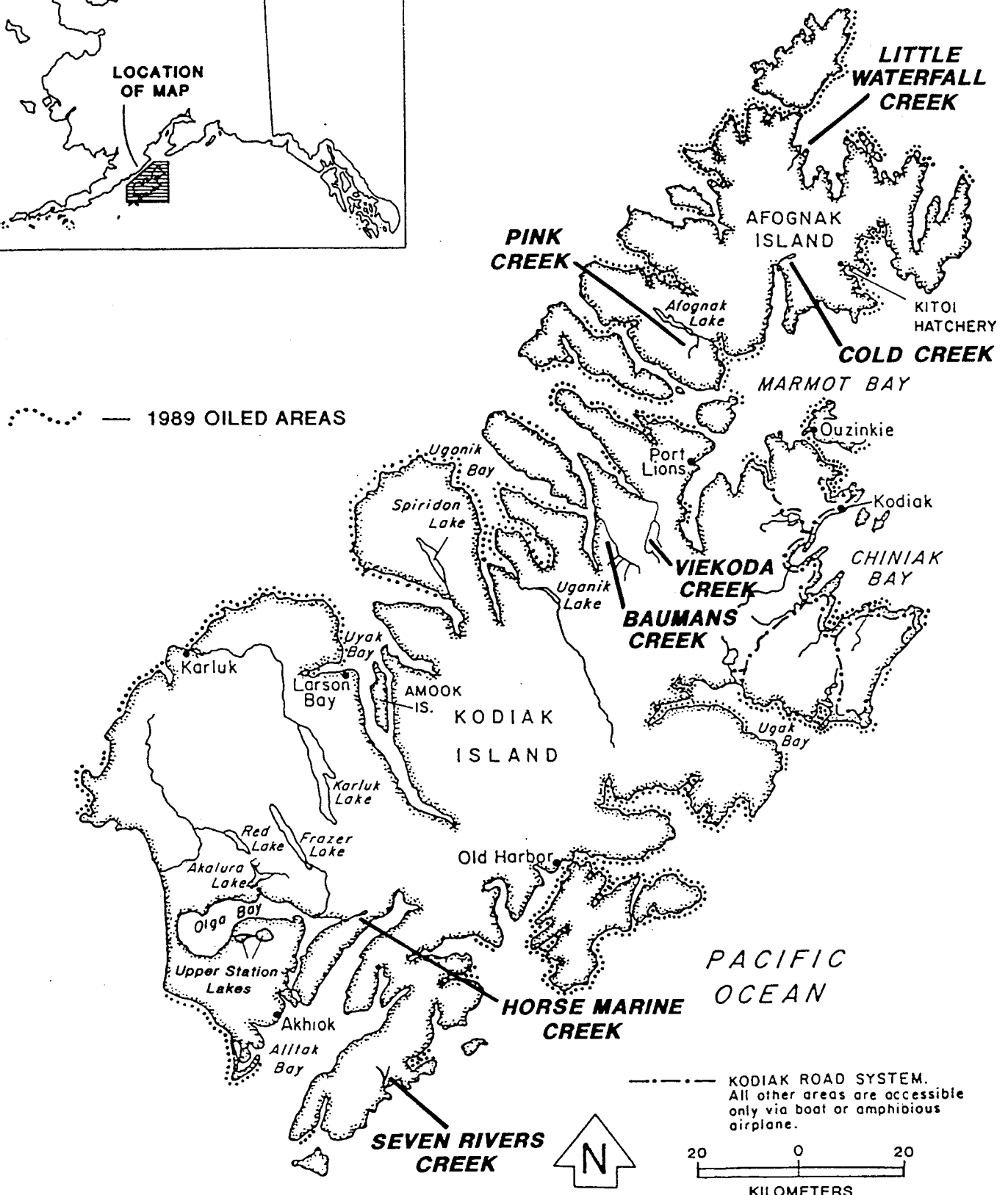
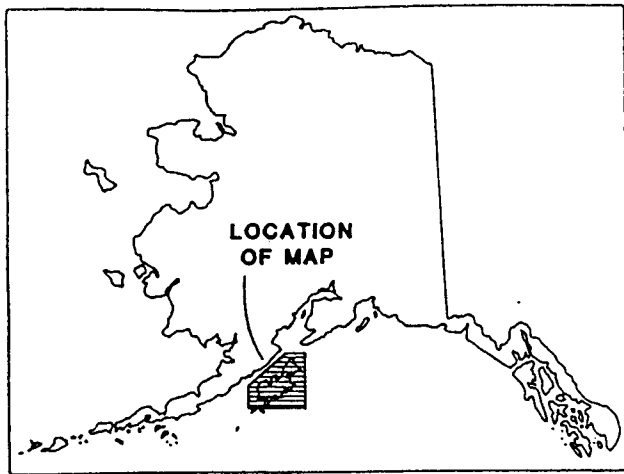

Figure 1. Location of 1989 oiled areas and salmon restoration/mitigation systems.

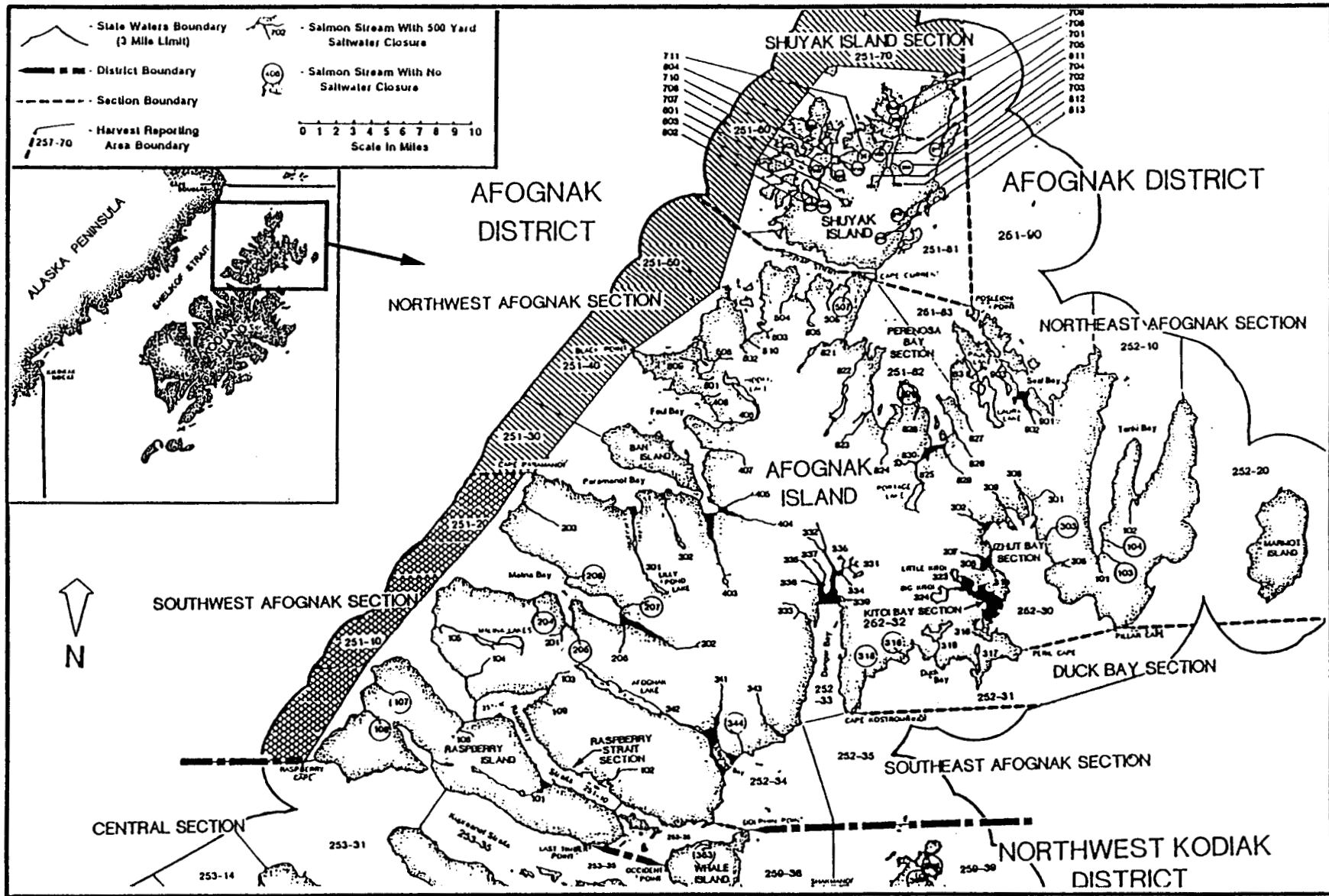

Figure 2. Afognak District of the Kodiak Management Area, 1994.

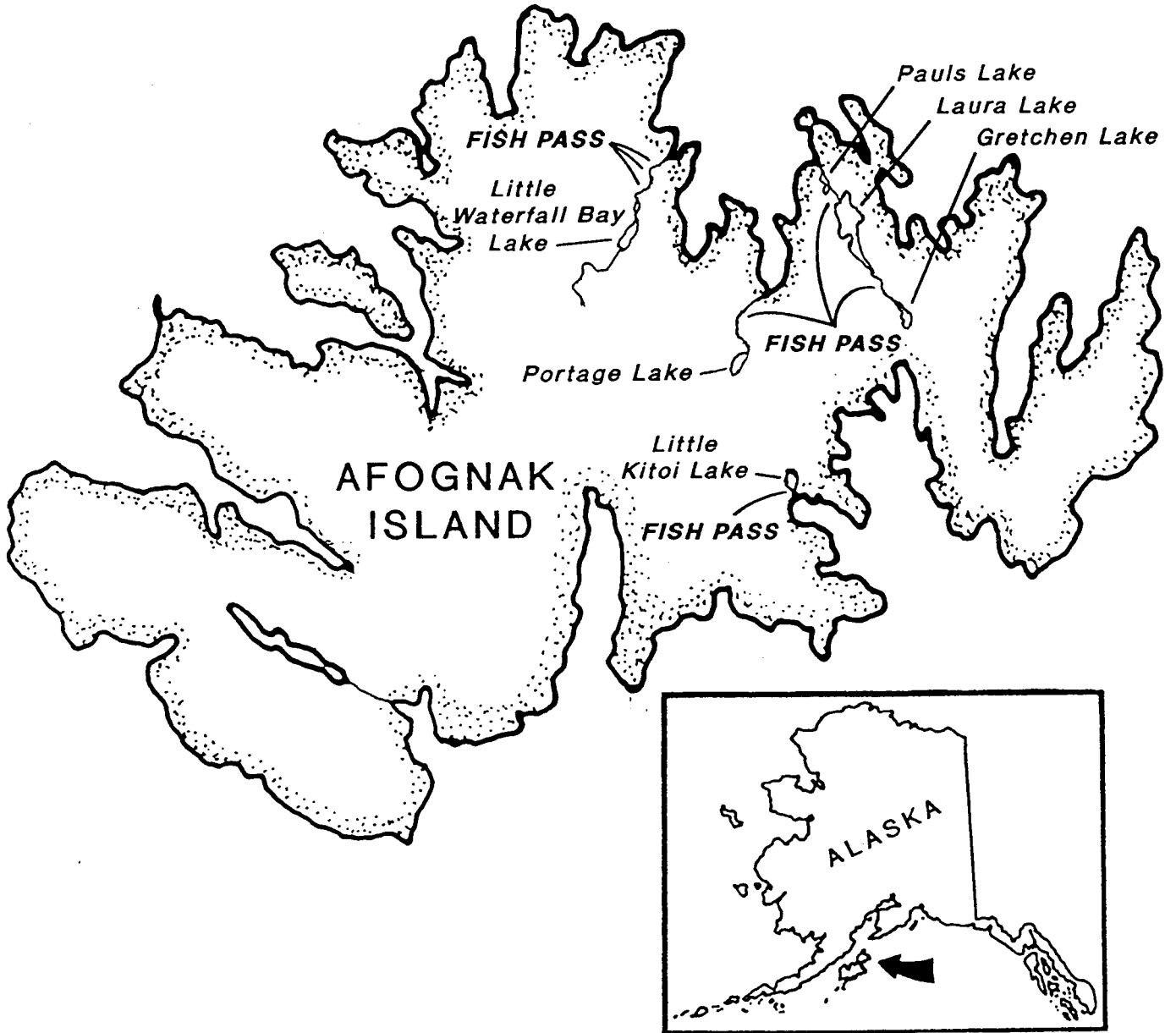
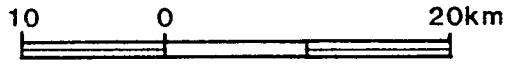
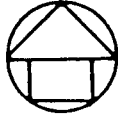

Figure 3. Location of operational fish passes on Afognak Island.

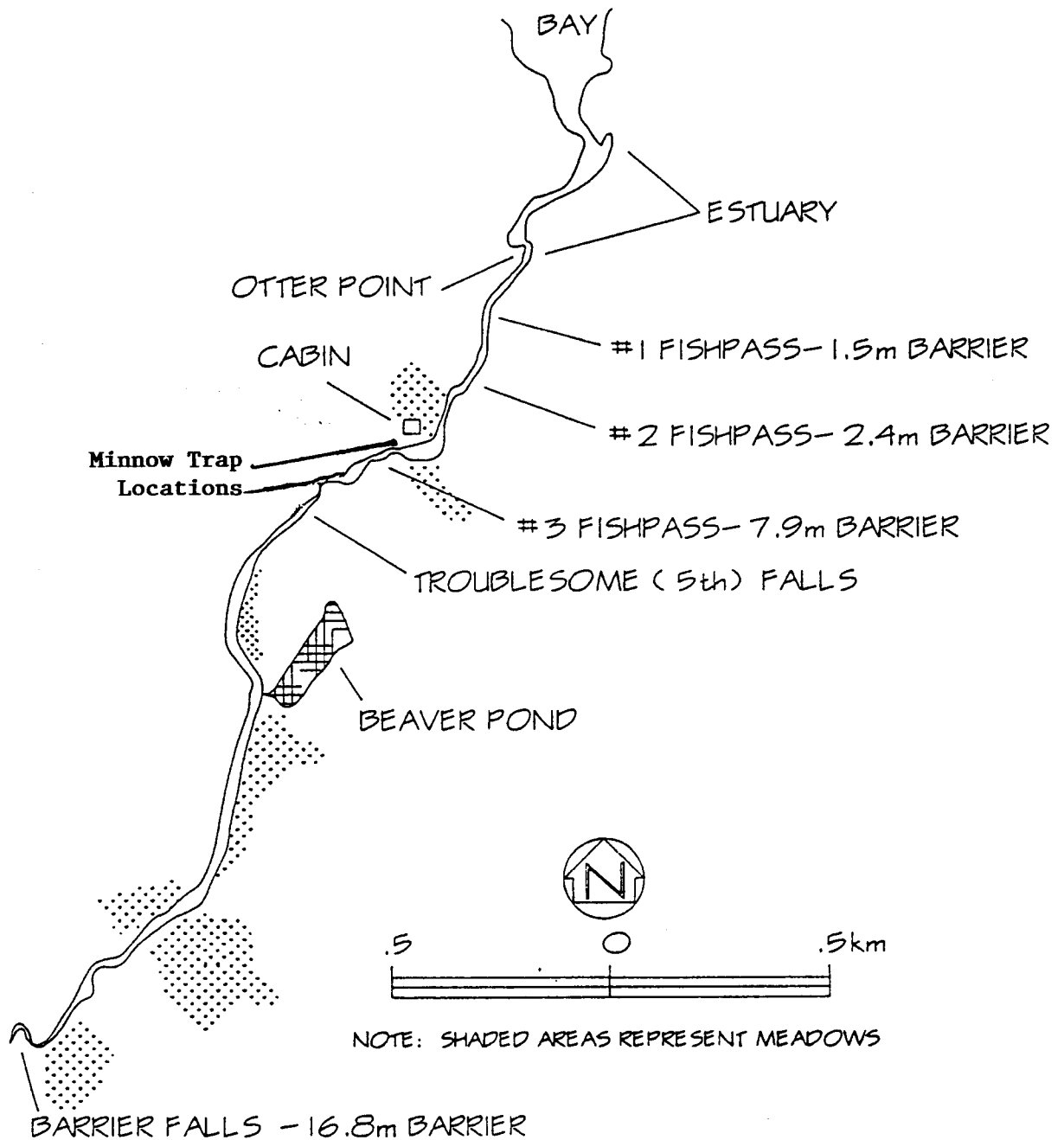

Figure 4. Location of bypasses (fishpasses), upstream spawning habitat, and minnow trapping sites at Little Waterfall Creek.

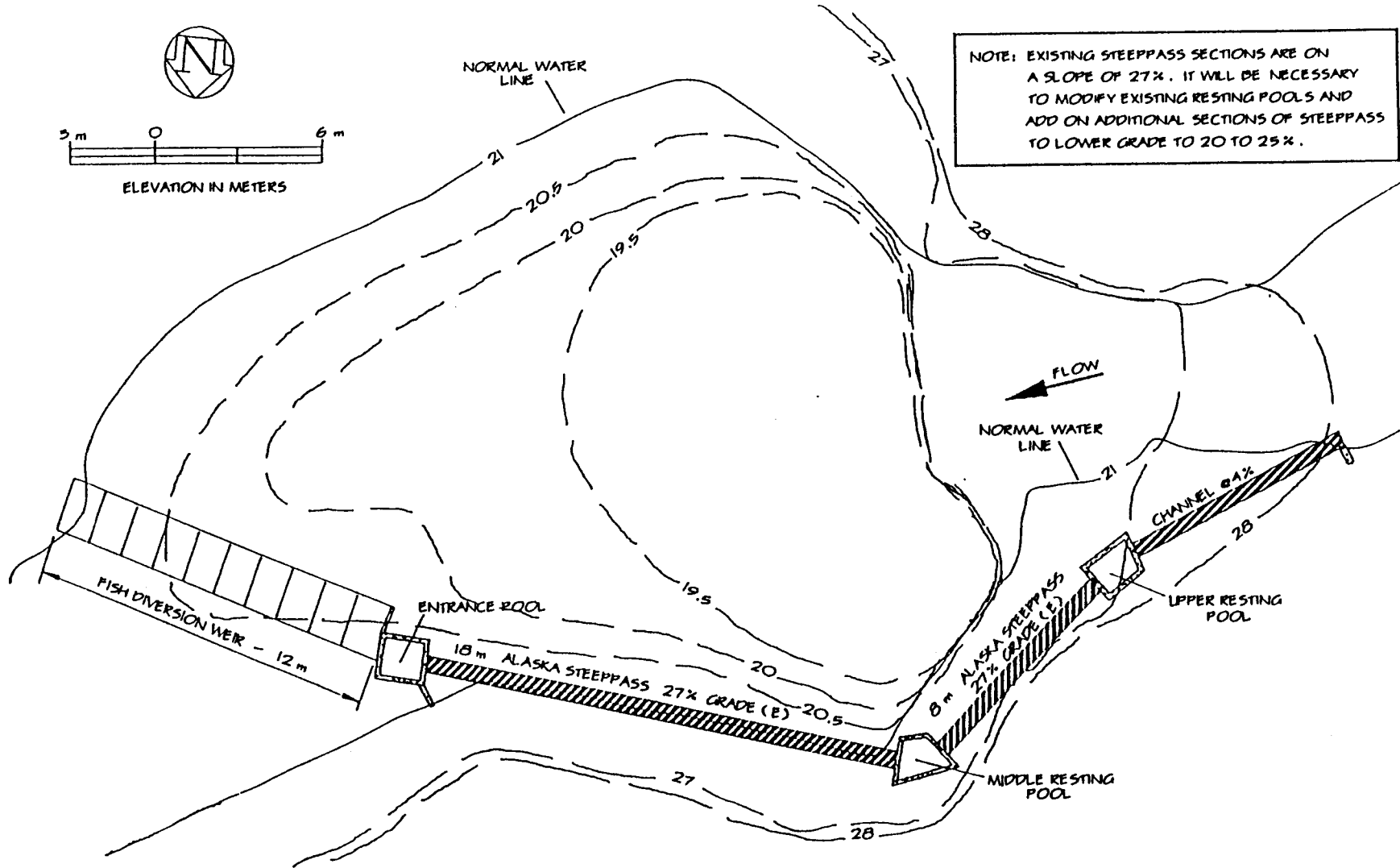

FIGURE 5 . DESIGN OF PRESENT BARRIER BYPASS AT 7.9 METER FALLS AND RECOMMENDED MODIFICATIONS TO IMPROVE SALMON PASSAGE.

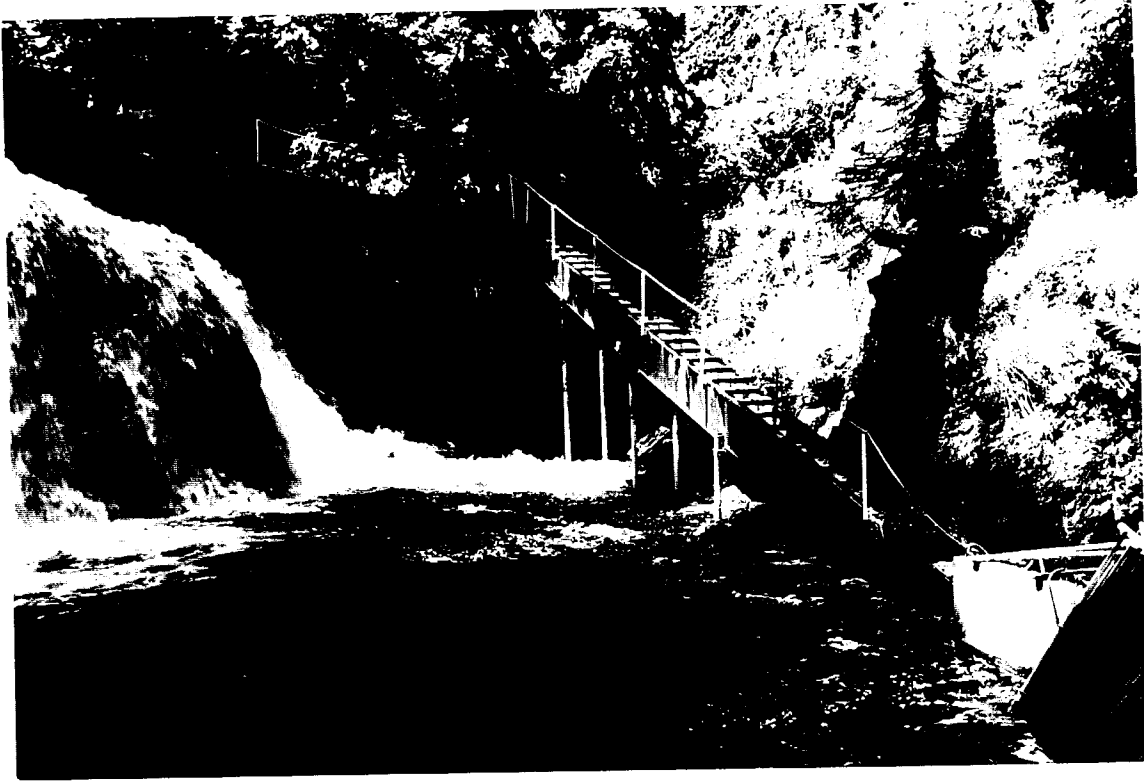
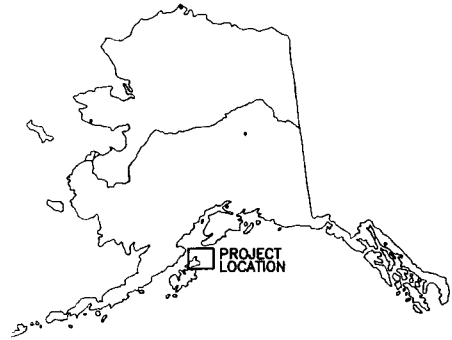

Figure 6. Photographs of Little Waterfall Creek barrier bypass prior to modifications.



STATE OF ALASKA
DEPARTMENT OF FISH & GAME

PROJECT NO. IHC 95-001

LITTLE WATERFALL CREEK FALLS #3
STEEPPASS IMPROVEMENTS

TITLE SHEET	1
SITE PLAN	2
ENTRANCE POOL & POOL #1 DETAILS	3
POOL #2 & POOL #3 ALUMINUM DETAILS	4
POOL #2 & POOL #3 FOUNDATION DETAILS	5
MIDDLE & UPPER RESTING POOLS, DETAILS	6

NOTE:
DRAWINGS MAY BE REDUCED
FROM SCALE SHOWN.

Figure 7-1: Little Waterfall Creek Falls #3 Steeppass Improvements

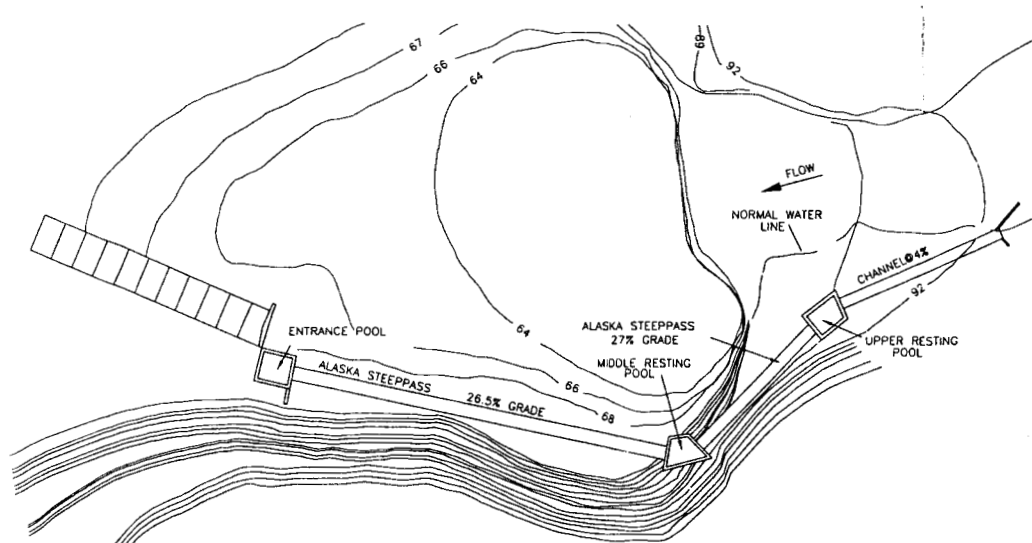

PLAN VIEW-EXISTING

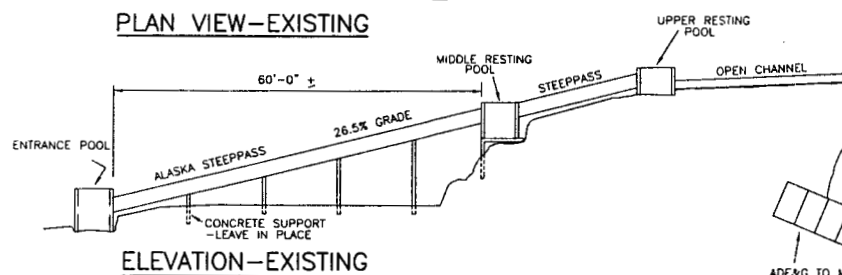

ELEVATION-EXISTING

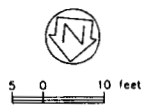

NOTE: ELEVATION CONTOURS WERE TAKEN FROM U.S.F.S. RECORD DRAWING DATED 3-3-80. DO NOT USE FOR CONSTRUCTION

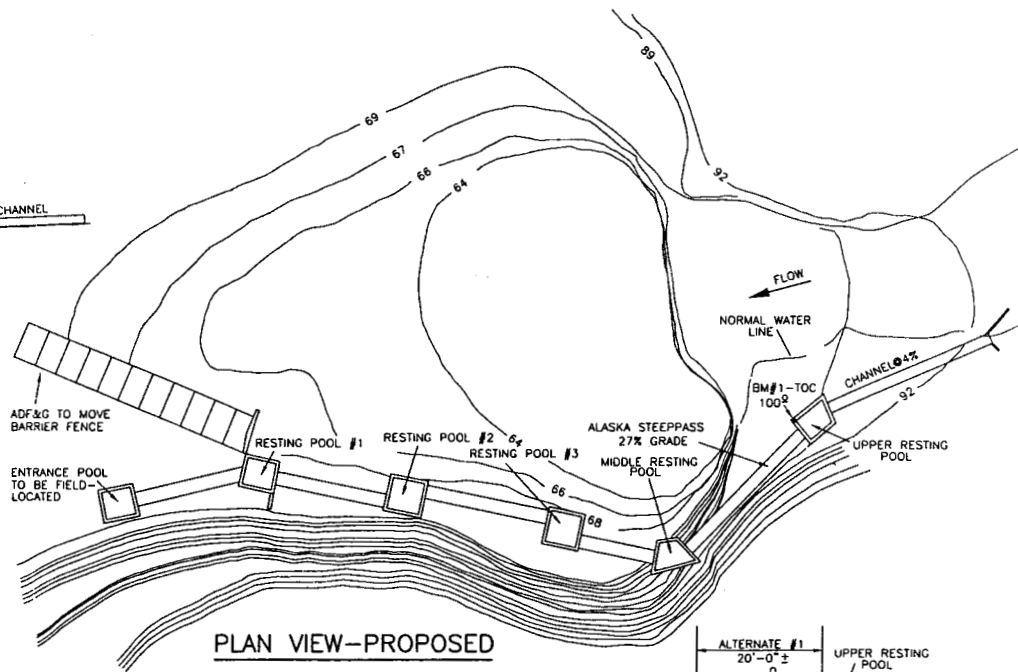

PLAN VIEW-PROPOSED

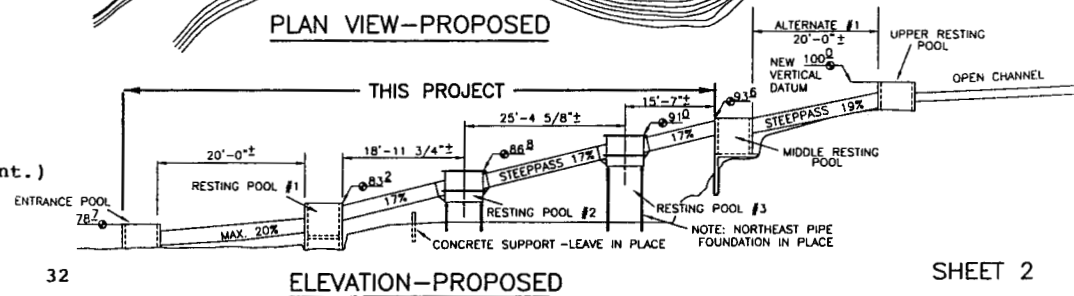

ELEVATION-PROPOSED

Figure 7-2: Little Waterfall Creek Falls #3 Steeppass Improvements (cont.)

INSTALL NEW TL COVER TO FIT
SEE SHEET 4 FOR TYPICAL FABRICATION

SEE SHEET 4 FOR WELDING DETAILS

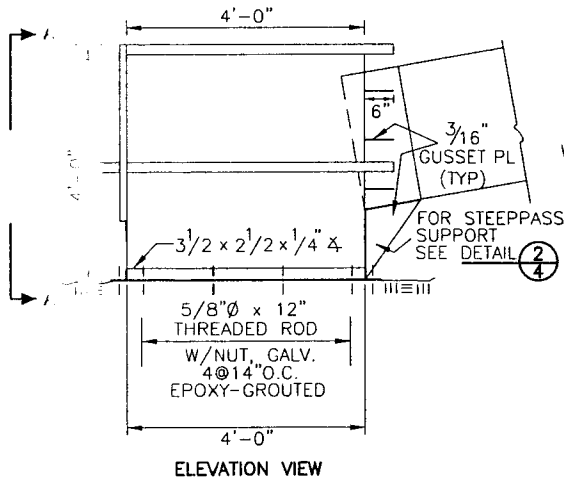
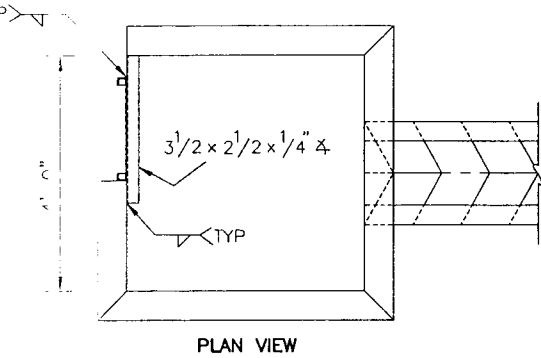
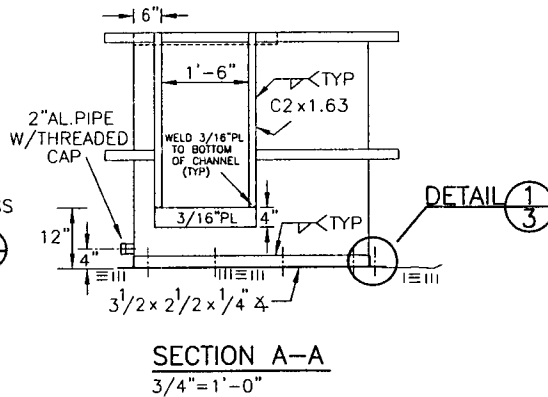
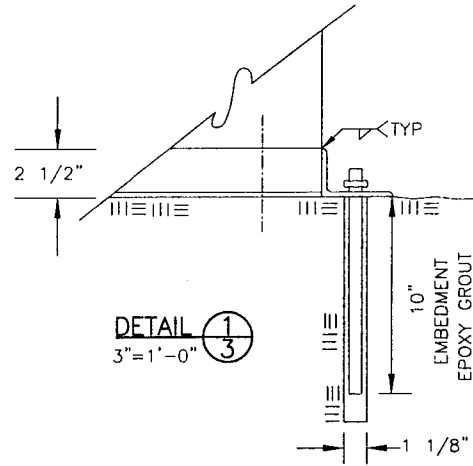

ENTRANCE POOL-ALUMINUM
3/4"=1'-0" (FIELD LOCATE)

FIGURE 7-3: Little Waterfall Creek Falls #3 Steeppass Improvements (cont.)

NOTE: COVER LATCH
SAME AS COVER HINGE

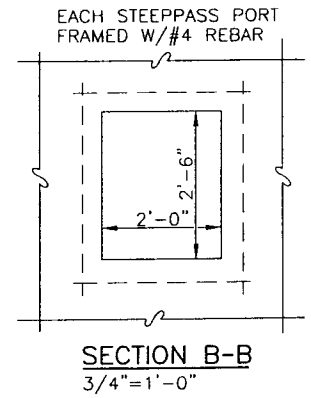
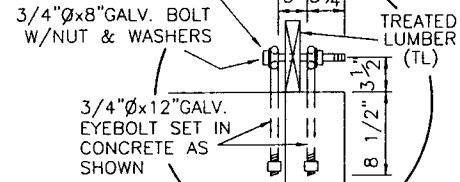

NOTE: REMOVE EXISTING WOODEN
POOL COVER & INSTALL ON TOP OF
BOX EXTENSION. SEE DETAIL 3
FOR EYEBOLT PLACEMENT.

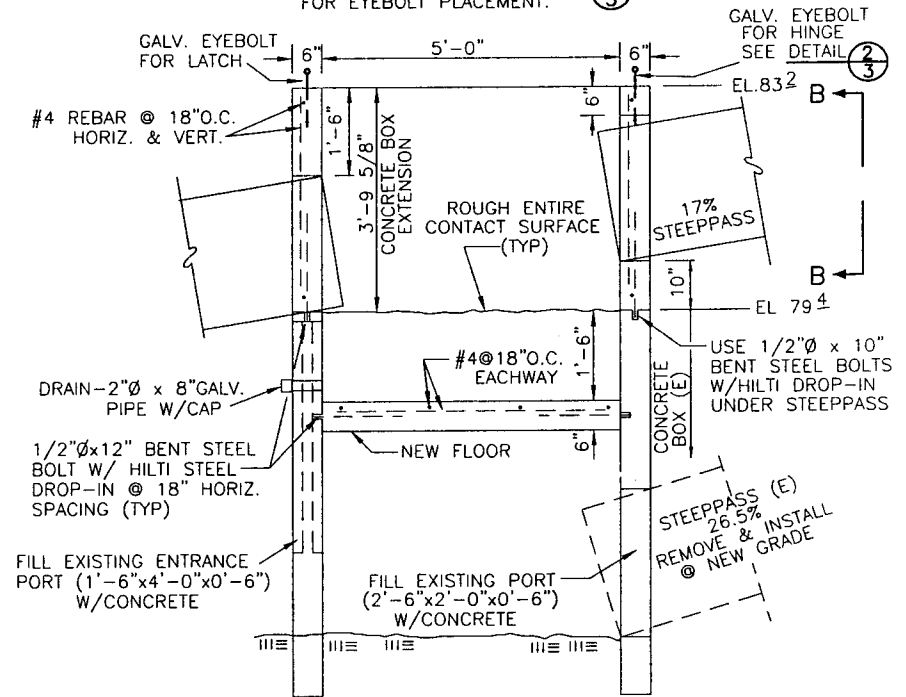

SHEET 3

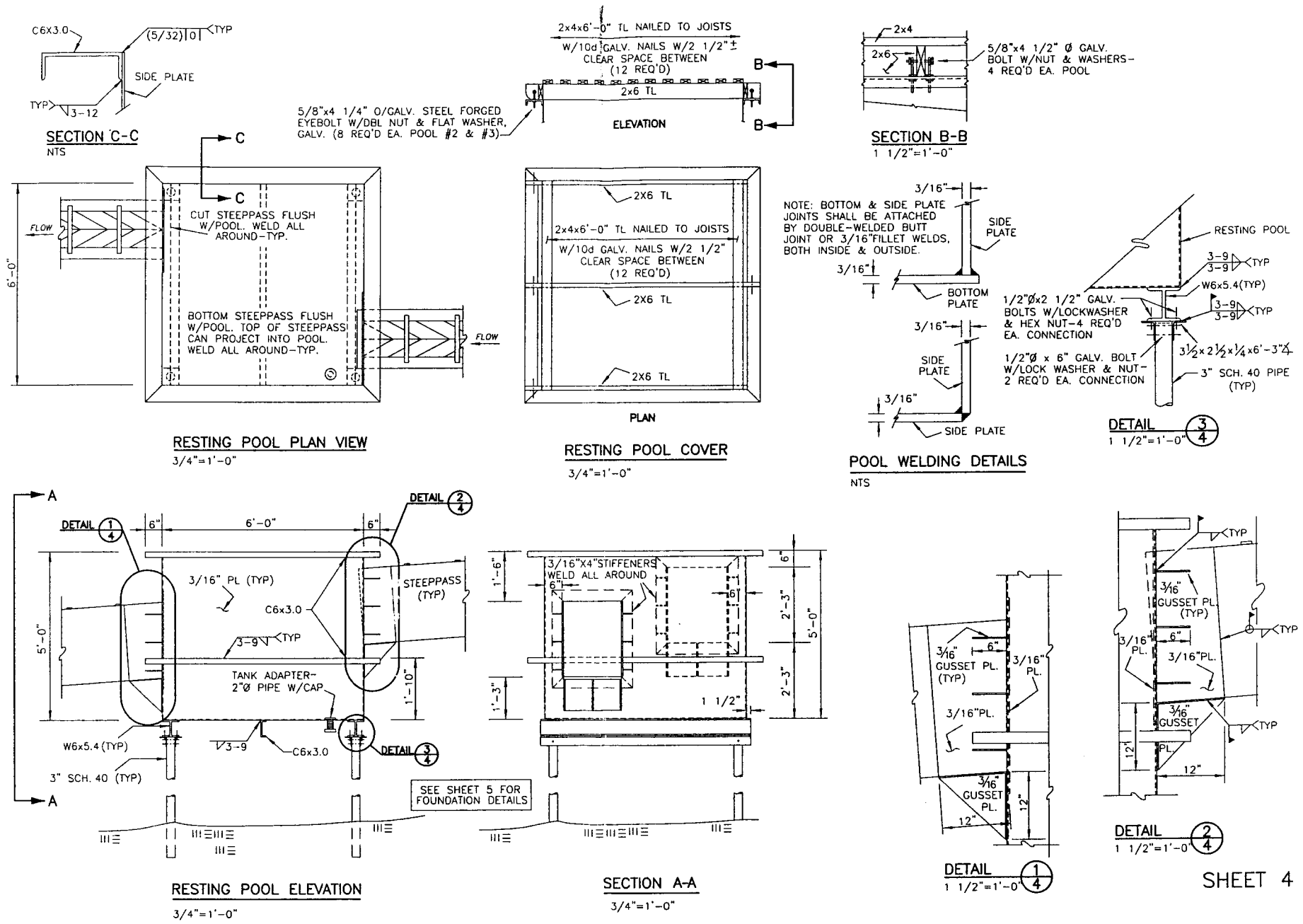

Figure 7-4: Little Waterfall Creek Falls #3 Steeppass Improvements (cont.)

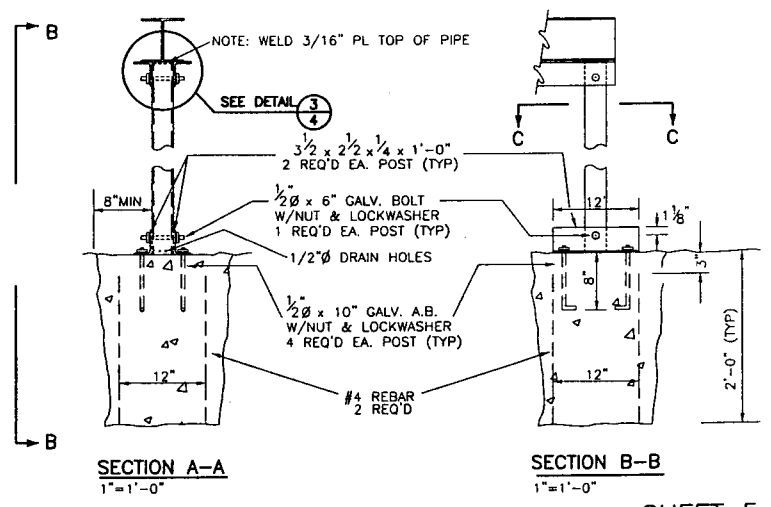
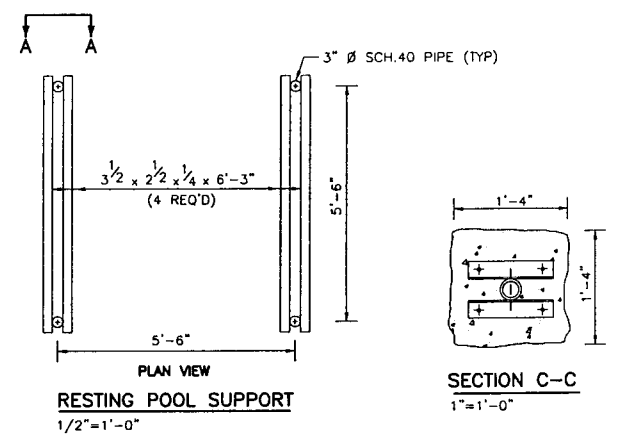
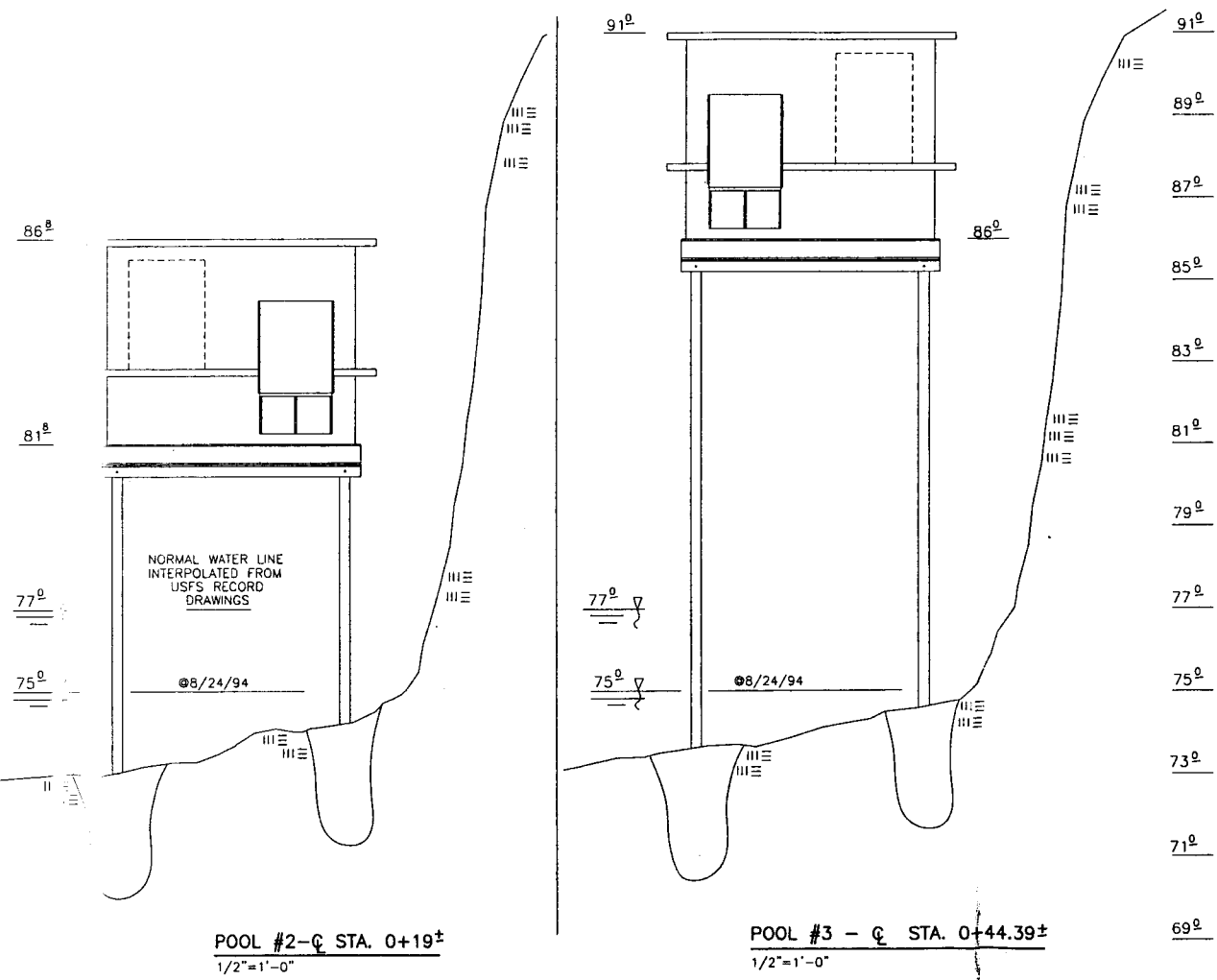

Figure 7-5: Little Waterfall Creek Falls #3 Steeppass Improvements (cont.)

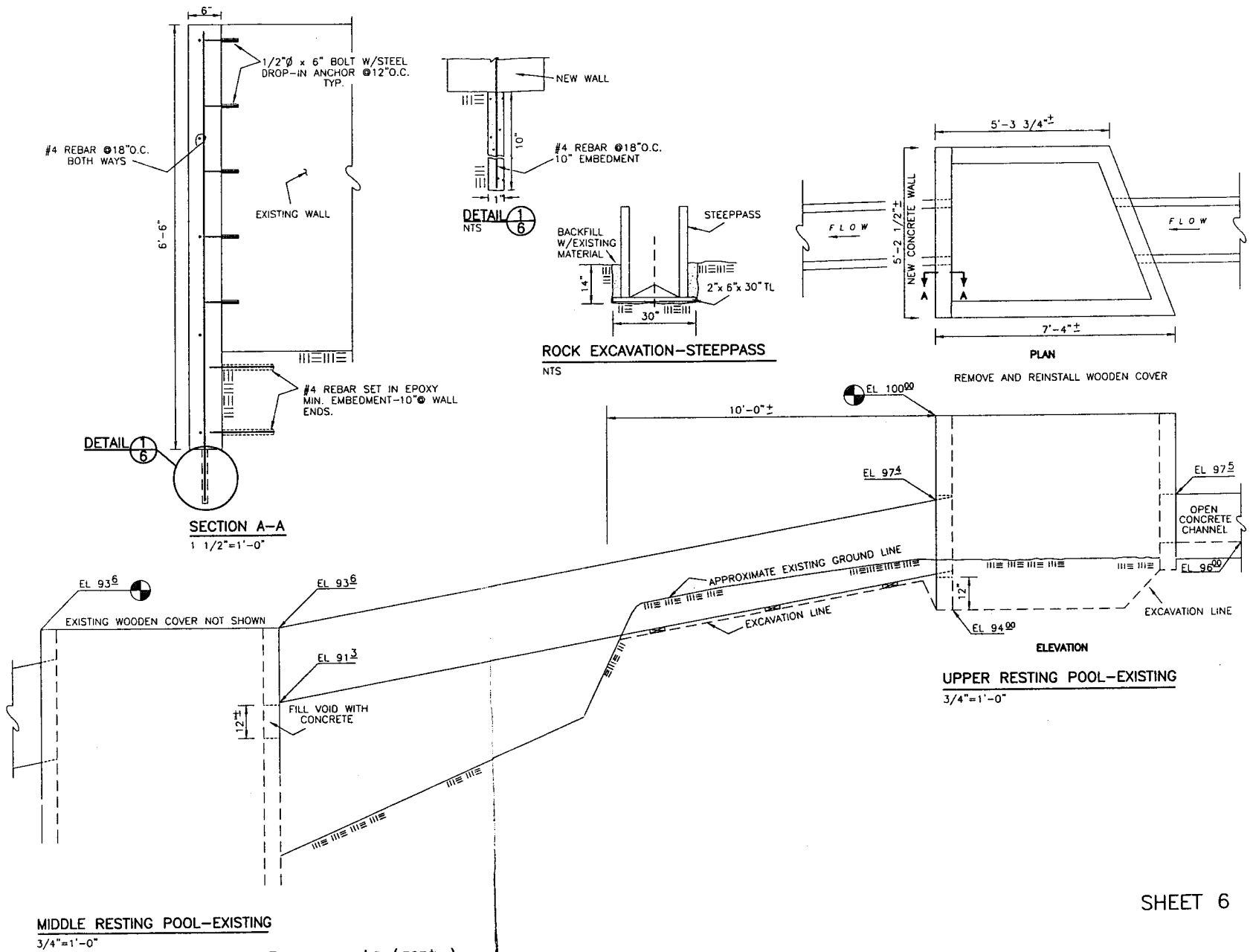
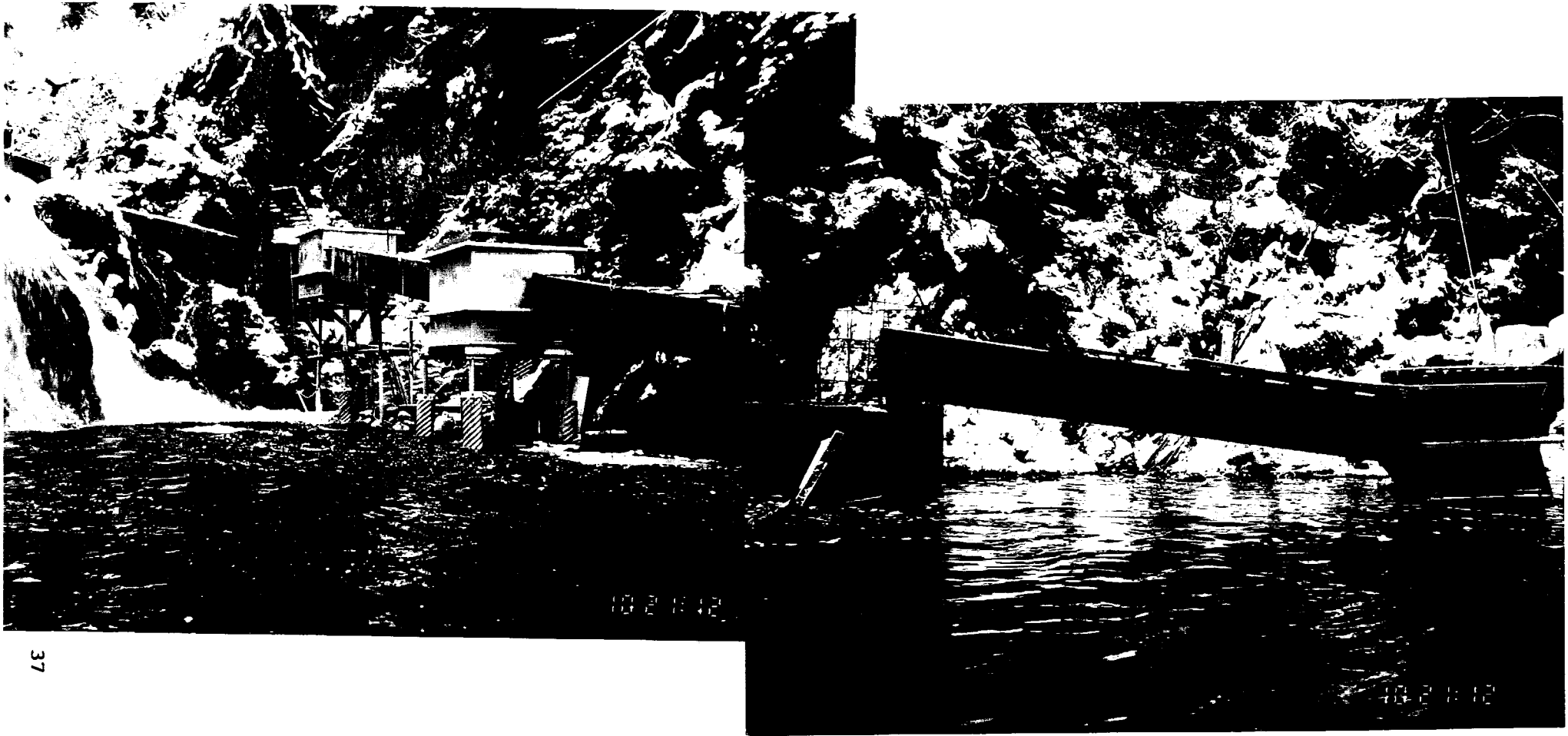

Figure 7-6: Little Waterfall Creek Falls #3 Steeppass Improvements (cont.)



37

Figure 8. Photograph of Little Waterfall Creek barrier bypass modification to reduce gradient and improve resting areas.

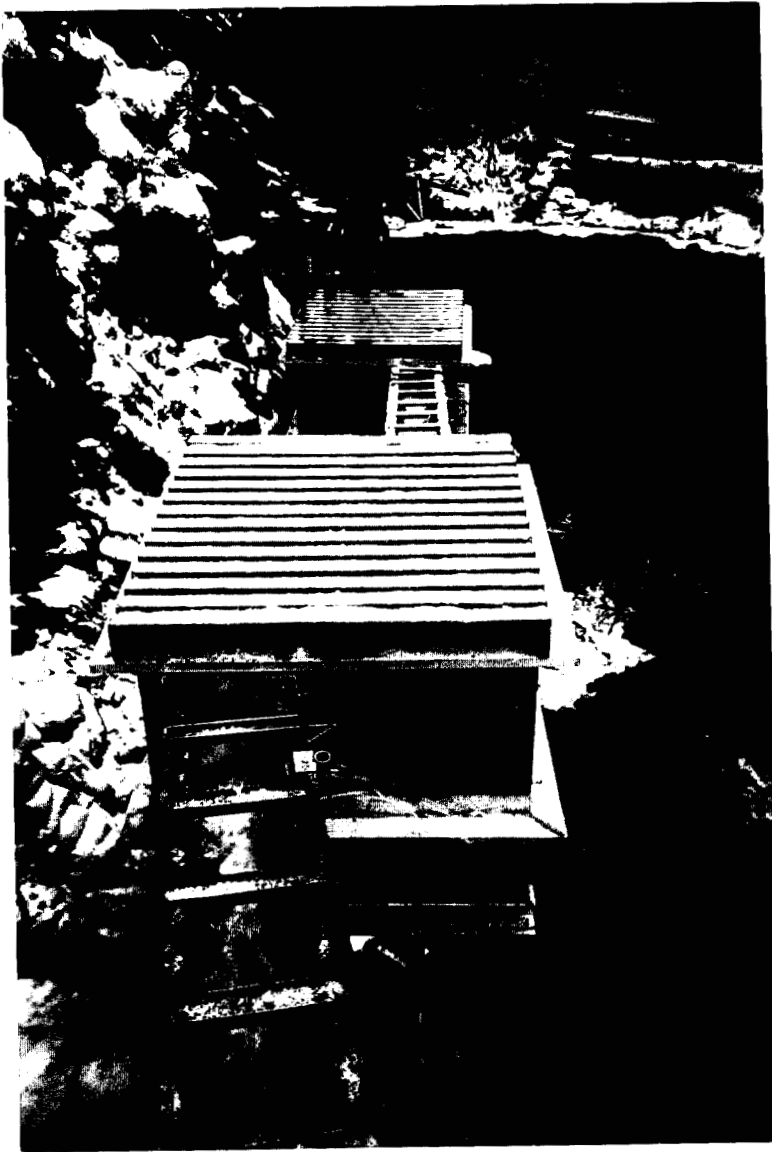

Figure 9. Modified barrier bypass at Little Waterfall Creek showing additional resting pools, and staggered steepass sections.

APPENDICES



STATE OF ALASKA
DEPARTMENT OF FISH & GAME
INVITATION FOR BIDS
for construction contract

Date: 4/17/95Project Number: IHC 95-001Name and Location of Project: STEEPPASS IMPROVEMENTS-AFOGNAK ISLAND, ALASKAContracting Officer: EARNIE GREEKIssuing Office: DEPARTMENT OF FISH & GAME, DIVISION OF ADMINISTRATION, JUNEAU HEADQUARTERS

Description of Work:

 State Funded Federal-Aid

Provide all labor, supervision, tools, equipment, materials and subsistence for improving the grade of the existing steppass to include two new aluminum resting pools, aluminum entrance pool, modification of existing concrete pools, covers, installation of additional state furnished steppasses and other miscellaneous work.

The Engineer's Estimate is (greater than, less than, between) \$85,000.00All work shall be completed in 120 Calendar Days, or by _____

Interim completion dates, if applicable, will be shown in the Special Provisions.

Sealed bids, in single copy for furnishing all labor, equipment and materials and performing all work for the above project are hereby invited. Bids will be opened publicly at 2:00pm local time, at ADF&G HEADQUARTERS OFFICE, JUNEAU, ALASKA on the 2nd of JUNE, 19 95.

SUBMISSION OF BIDS

ALL BIDS INCLUDING ANY AMENDMENTS OR WITHDRAWALS MUST BE RECEIVED PRIOR TO BID OPENING. BIDS SHALL BE SUBMITTED ON THE FORMS FURNISHED AND MUST BE IN A SEALED ENVELOPE MARKED AS FOLLOWS:

Bid for Project:	State of Alaska
<u>IHC 95-001</u>	<u>DEPARTMENT OF FISH & GAME</u>
<u>LITTLE WATERFALL CREEK FALLS #3</u>	<u>P.O. BOX 25526</u>
<u>STEEPPASS IMPROVEMENTS</u>	<u>JUNEAU, ALASKA 99802-5526</u>

The above address is for bids only. Bids, amendments or withdrawals transmitted by mail must be received in the above specified post office box no later than 30 minutes prior to the scheduled time of bid opening. Hand-delivered bids, amendments or withdrawals must be received by the **Contracts Officer**, at (907) 465-6180 prior to the scheduled time of bid opening. Telefacsimile bid amendments must be addressed to **Contracts Officer**. Telefacsimile number: (907) 465-6078

A proposal guaranty is required with each bid in the amount of 5% of the amount bid. (Alternate bid items as well as supplemental bid items appearing on the bid schedule shall be included as part of the total amount bid when determining the amount of proposal guaranty required for the project.)

The Department hereby notifies all bidders that it will affirmatively insure that in any contract entered into pursuant to this Invitation. Disadvantaged Business Enterprises (DBEs) will be afforded full opportunity to submit bids and will not be discriminated against on the grounds of race, color, national origin or sex in consideration for an award.

NOTICE TO BIDDERS

Bidders are hereby notified that data to assist in preparing bids is available as follows:

Plans and Specifications may be ordered for the price of \$25.00 (non-refundable)

Plans and Specifications may be ordered for the price of \$ 25.00 . from:

CAROL SCHNEIDERHAN
333 RASPBERRY ROAD
ANCHORAGE, ALASKA 99518-1599

Phone: (907) 267-2239

All questions relating to design features, constructability, quantities, or other technical aspects of the project should be directed to the following. Bidders requesting assistance in viewing the project must make arrangements at least 48 hours in advance with:

STEVE HONNARD-FISH BIOLOGIST-ADF&G, KODIAK, ALASKA

Phone: (907) 486-1873

All questions concerning bidding procedures should be directed to:

ELMER SORENSON, FACILITY COORDINATOR

Phone: (907) 465-6180

Other Information:

All other questions relating to the design features, constructability, quantities, or other technical aspects of the project should be directed to:

BRUCE McCURTAIN
DIVISION ENGINEER

Phone: (907) 267-2237

Fax: (907) 349-5532

Appendix 2. Abstract presented at 1995 Restoration Workshop.

PROJECT NUMBER AND TITLE: 94139A1 - Salmon Instream Habitat and Stock Restoration - Little Waterfall Barrier Bypass Improvement.

PRINCIPAL INVESTIGATOR: Steven G. Honnold, Alaska Department of Fish and Game, Commercial Fisheries Management and Development Division, 211 Mission Road, Kodiak, Alaska, 99615 (907) 486-1873.

ABSTRACT: Restoration work began at Little Waterfall Creek in 1994 as result of surveys conducted on Kodiak Island to evaluate instream habitat and stock restoration techniques for wild salmon stocks. Data from these surveys indicated that Little Waterfall Creek contained a significant amount of spawning habitat that was under utilized by pink and coho salmon due to an ineffective barrier bypass structure. Further surveys revealed that this barrier bypass structure was deficient due to steep gradients and excess water velocity. The primary objective of this restoration project was to improve salmon passage upstream of the barriers to allow full utilization of spawning habitat. The priorities of the project were to design renovations to the bypass to reduce the gradients and to the resting pools to minimize water velocity. In conjunction with the renovation work, pink and coho salmon production data were to be further assessed to determine pre-project status. This included escapement, egg-to-fry survivals, and rearing abundance (coho) upstream and downstream of the barrier. A survey was completed in August 1994 to enable final design of the bypass renovation. The final design included reduction of gradients from 27% to 17-20% and the addition of two resting pools and an entrance pool. The steppass sections would be staggered between pools to reduce the velocity of stream flows. Juvenile sampling for egg-to-fry survival as well as adult coho salmon escapement surveys, conducted in 1994, indicated poor juvenile production and few spawners in upper habitat.

Appendix 3.

April 7, 1995

TO: Molly McCammon
FROM: Robert B. Spies *RBSp*
CC: Bill Hauser
Steve Honnold
RE: Project 95139A-1 (Salmon Instream Habitat and Stock Restoration – Little Waterfall Barrier Bypass Improvement)

I received the review of the above project on March 31, 1995. The reviewer raises several questions that will be important for the principal investigator to consider as the project is implemented, and when assessing the overall success of the project. However, none of the reviewer's comments are serious enough to delay implementation of the project.

I consequently recommend that the above project be approved for full funding, with the provision that the principal investigator will consider the enclosed comments of the peer reviewer during project implementation and assessment.

Please note that this recommendation applies only the work proposed for Little Waterfall Creek. During the fish supplementation workshop held in Anchorage in January, several issues were raised relative to other portions of 94/95139 (Pink Creek, Horse Marine Creek, and Port Dick Creek). ADF&G and USFS will need to address these concerns, which were described in my February 7 memo to you ("Report and Recommendations from the Fish Supplementation Workshop"), in revised DPDs for these portions of project 94/95139.



General comments and recommendations

The proposed project appears to be a technically sound means of increasing pink and coho salmon population levels in the affected area. The proposed barrier bypass improvements provide a proven means of improving access to an area which earlier studies have shown to contain the capacity to support increased spawning populations. I have confidence that the project can produce the results expected, and I see no technical problems which would be reason to delay its implementation.

A number of deficiencies detract from the overall utility of the proposal. First of all, neither the discussion nor the objectives mention evaluation of effects of enhancement on fish and other associated species which may be resident in the affected areas. Are there resident species, and, if so, what would be the impact of salmon enhancement on them? Second, although the proposal appears to assume that seeding of the affected spawning grounds would occur by means of colonization from salmon populations which now exist in non-affected areas, I could not find this stated in the proposal. Third, since juvenile coho salmon eat juvenile pink salmon, some discussion of the potential for interspecific competition to reduce the actual benefits of the enhancement project should occur. Fourth, I could find no discussion of how harvest regulations would be designed to take advantage of the increased salmon production, or whether there is any potential for mixed stock harvest management dilemmas to be created by the increased production (the materials on page 11 do not suffice). Fifth, there are no calculations shown, nor is any literature cited, which would allow the reader to evaluate the reasonableness of either the annual production potential attributed to the affected areas (48,000 pink salmon and 17,700 coho salmon), or the annual spawning capacities (24,000 pink; 2,700 coho) attributed to the affected areas. Sixth, the literature citations are too few.

Specific items needing improvement

Page 8 Item 5. The benefits of the project are cited (p. 8) as 24,000 pink salmon and 15,000 coho salmon for harvest. On page 3, the proposal states that the habitat above the barrier, "... can support 24,000 and 2,700 coho salmon, respectively." and the harvest benefits of 24,000 pinks and 15,000 coho are also given on page 3. Do these statements envision annual harvest rates of 50% for pink salmon and just under 85% for coho? It would be helpful to state how the figures for both spawning capacities and appropriate harvest rates were derived, and how the harvests could be managed to achieve these harvest rates.



Appendix 4. Response to peer review of FY 96 Detailed Project Description for Little Waterfall Barrier Bypass Improvement.

STATE OF ALASKA

DEPARTMENT OF FISH AND GAME

DIVISION OF COMMERCIAL FISHERIES MANAGEMENT AND DEVELOPMENT

TONY KNOWLES, GOVERNOR

211 Mission Road
KODIAK, AK 99615
PHONE: (907) 486-1873
FAX: (907) 486-1841

June 14, 1995

Ms. Molly McCammon
Executive Director
Exxon Valdez Oil Spill Trustee Council
Restoration Office
645 G. Street, Suite 401
Anchorage, Alaska 99501-3451

Dear Ms. McCammon:

I am writing you in response to your memorandum of April 10, 1995 to Joe Sullivan regarding Project 95139A/Salmon Instream Habitat and Stock Restoration - Little Waterfall Creek Barrier Bypass. I apologize for the delay in my response. I interpreted your letter as approval of the DPD and FY95 budget with the response to peer review comments due prior to field work. Apparently, this was a misinterpretation on my part, and funds are now on hold until comments are provided. Thus, this letter includes my response to Dr. Spies comments on the DPD as follows:

1) "The discussion nor the objectives mention evaluation of effects of enhancement on fish and other associated species which may be resident in the affected areas. Are there resident species, and if so, what would be the impact of salmon enhancement on them?"

Yes, there are resident species in Little Waterfall Creek. These include Dolly Varden char (*Salvelinus malma*), rainbow or steelhead trout (*Oncorhynchus mykiss*), three spine stickleback (*Gasterosteus aculeatus*), freshwater sculpin (*Cottus aleuticus*), and a small number of sockeye salmon (*O. nerka*). The abundance of Dolly Varden has not been documented in recent years, however, I have not observed more than fifty in my stream walks on the system. The steelhead trout population is minimal, with usually less than a dozen observed from May through October. The target species of this project, pink (*O. gorbuscha*) and coho salmon (*O. kisutch*) have also occurred in the system historically. Pink salmon escapements of a few thousand occurred prior to the construction of the three fishpasses in the 1970's and early 1980's. Coho salmon numbers were minimal (not a lot of documentation) prior to the project. The initial enhancement work, targeting pink salmon, occurred after interagency review (ADF&G and the USFS) of the proposed project. Although I have not taken the time to locate and review comments by the agencies, I assume that the necessary habitat permit requirements were adhered to, allowing construction and operation of the fishpasses. Habitat permitting requirements, in most cases, address non-target species habitat requirements. Thus, I believe this question has been addressed appropriately in the past. In addition, the habitat permits for modification to the third fishpass have been approved and plans have been made to adhere to permitting requirements. The increased production of pink salmon fry will provide additional forage for both steelhead and Dolly Varden. In addition, spawning habitat availability for both species will be increased by the project.

2) "the proposal appears to assume that seeding of the affected spawning grounds should occur by means of colonization from salmon populations that now exist in no-affected areas" - not stated in the proposal.

The seeding of habitat not presently at full production will be by natural colonization.

3) "since juvenile coho salmon eat pink salmon, some discussion of the potential for interspecific competition to reduce the actual benefits of the enhancement project should occur."

The majority of salmon producing systems on Kodiak Island produce both pink and coho salmon. I agree that some pink salmon fry will be eaten by juvenile coho salmon. Temporal and spatial separation contributes to the coexistence and success of both species. Pink salmon fry emerge from mid March to late May at L. Waterfall and immediately move out of the freshwater to the estuary. Since spawning habitat requirements between the species vary at L. Waterfall, juvenile coho are often found in areas that pink salmon fry are not, thus, possibly, limiting some interspecific competition. There is, however, definitely overlap, as with all other Kodiak salmon systems. If spawning habitat access is improved, then both species should have equal opportunity to utilize it and produce juveniles. Interspecific competition would remain at a similar level as occurring now if the rate of increased escapement is similar for each species. The improved habitat access will, potentially, be more beneficial to pink salmon, since rearing habitat is the limiting factor for coho salmon, thus indigenous species should benefit or be unaffected by the project.

4) " how will harvest regulations be designed to take advantage of the increased salmon production, and is there any potential for mixed stock harvest management dilemmas to be created by the increased production?"

All salmon systems in Alaska are managed for optimum escapement. Salmon fisheries in the Kodiak Management Area (Area K) are managed to provide for potential maximum production of future returns, to provide for orderly fisheries on high quality salmon, and to meet allocative requirements of the Board of Fish. The harvest strategy for pink salmon produced at L. Waterfall is part of the overall Area K pink salmon harvest strategy and includes a fixed opening date of July 6, a forecasting program (based on preemergent fry sampling indices and ambient temperature) to set the length of the initial fishing periods, and coordination of multiple fisheries when possible to disperse the fleet. The fishing periods are based on the forecast and, generally, occur 3.5 days weekly from July 6 - August 25, but may extend to seven days a week during peak harvest periods (late July through mid August). This harvest strategy is not expected to change with increased pink salmon production from this project. More fishing time and closed water boundaries can be adjusted in the event of extremely large runs. Coho harvest strategy in Area K is based on reaching the optimum escapements. This harvest strategy is expected to provide for adequate management of coho returns generated by this project.

5) "there are no calculations shown, nor is any literature cited, which would allow the reader to evaluate the reasonableness of either the annual production potential attributed to the affected areas or the annual spawning capacities attributed to the affected areas."

The following spawner density, fecundity, survivals and exploitation rates were used as planning assumptions to forecast pink and coho salmon production benefits for this project:

Parameter	Mean	Source (Area)
<u>Pink Salmon</u>		
Optimum female density (#/sq.m)	0.7	Heard (1978)
Average fecundity	1858	Prince William Sound
Egg-fry survival (%)	6.4	SE Alaska
Marine survival rate (%)	3.1	Alaska
Exploitation rate (%)	54	Kodiak
Parameter	Mean	Source (Area)

Parameter	Mean	Source (Area)
<u>Coho Salmon</u>		
Optimum female density (#/sq.m)	0.08	Shang et al (1990)
Average fecundity	4835	Alaska
Egg-fry survival (%)	7.4	Kodiak
Marine survival rate (%)	4.1	Washington, California
Exploitation rate (%)	75	Chapman (1986)

Spawning habitat evaluation parameters are described in the final report for Restoration Project 93063, Survey and Evaluation of Instream Habitat and Stock Restoration Techniques for Wild Pink and Chum Salmon. This report was authored by Willette, Dudiak, and Honnold and submitted in 1995.

6) "Literature citation are too few."

The attached pages from the final report for Restoration Project 93063, as described above, provide citations. Please refer to this report for additional information if needed.

This completes my response to Dr. Spies comments. If additional information is needed I will be happy to provide it at your convenience. Thank you for the opportunity to comment.

Sincerely,

Steven G. Honnold
Fishery Biologist

Attachment:

cc: Bob Spies
Traci Cramer
Bill Hauser
Joe Sullivan
Bruce McCurtain
Pete Probasco
Wayne Donaldson