

Exxon Valdez Oil Spill
Restoration Project Annual Report

Otolith Marking of Pink Salmon in Prince
William Sound Salmon Hatcheries, 1995

Restoration Project 95320C
Annual Report

This annual report has been prepared for peer review as part of the *Exxon Valdez* Oil Spill Trustee Council restoration program for the purpose of assessing project progress. Peer review comments have not been addressed in this annual report.

Timothy L. Joyce
David G. Evans
Renate R. Riffe

Alaska Department of Fish and Game
Commercial Fisheries Management and Development Division
401 Railroad Avenue
Cordova, Alaska 99574

February 1996

Exxon Valdez Oil Spill
Restoration Project Annual Report

Otolith Marking of Pink Salmon in Prince
William Sound Salmon Hatcheries, 1995

Restoration Project 95320C
Annual Report

This annual report has been prepared for peer review as part of the *Exxon Valdez* Oil Spill Trustee Council restoration program for the purpose of assessing project progress. Peer review comments have not been addressed in this annual report.

Timothy L. Joyce
David G. Evans
Renate R. Riffe

Alaska Department of Fish and Game
Commercial Fisheries Management and Development Division
401 Railroad Avenue
Cordova, Alaska 99574

February 1996

Otolith Marking of Pink Salmon in Prince
William Sound Salmon Hatcheries, 1995

Restoration Project 95320C
Annual Report

Study History: After the *Exxon Valdez* oil spill, separation of hatchery and wild stocks was accomplished through coded wire tag recoveries in the salmon fisheries of Prince William Sound (PWS). Thermal otolith marking is a relatively new technology capable of providing more precise and accurate estimates at lower costs than those afforded by the CWT program. In 1995, the first otoliths of hatchery pink salmon were marked with the vision that the technique would eventually replace the CWT program as a tool for stock separation of PWS pink salmon.

Abstract: Otolith mass marking of hatchery pink salmon *Oncorhynchus gorbuscha* is introduced as a potential replacement for coded wire tag technology in an effort to provide more precise and accurate information to the fishery personnel charged with managing the mixed stock fisheries in PWS. All four pink salmon hatcheries in PWS installed water heating systems at a cost of \$573,600 to the EVOS Trustee Council to allow rapid and sustained temperature changes to the incubation water. Thermal marks were applied on the otoliths of approximately 684.7 million pink salmon embryos in PWS in 1995. Each hatchery was assigned a distinct thermal mark to allow separation between hatchery stocks and wild stocks in returning adults. A preliminary study was undertaken to determine the amount of mixing that occurs on tenders from the time salmon are taken aboard to the time they are unloaded at the processor. The results of this study will be used in determining the complexity of the otolith sampling program required to provide managers with information on the hatchery and wild stock composition of the common property fishery.

Key Words: Commercial harvest, hatchery, *Oncorhynchus gorbuscha*, otolith, pink salmon, Prince William Sound, thermal mark, wild stock.

Citation

Joyce, T.L., D.G. Evans, and R.R. Riffe. 1996. Otolith marking of pink salmon in Prince William Sound hatcheries, 1995, *Exxon Valdez* Oil Spill Restoration Project Annual Report (Restoration Project 95320C), Alaska Department of Fish and Game, Commercial Fisheries Management and Development Division, Cordova, Alaska.

TABLE OF CONTENTS

STUDY HISTORY/ABSTRACT/KEY WORDS/CITATION.....	i
LIST OF TABLES.....	iii
LIST OF FIGURES.....	iv
LIST OF APPENDICES.....	v
EXECUTIVE SUMMARY.....	1
INTRODUCTION.....	2
OBJECTIVES.....	4
METHODS.....	5
Equipment Purchase and Installation.....	5
Application of Thermal Marks.....	5
Determination of the Travel-induced Redistribution of a Localized Collection of Marks within a Tender.....	6
RESULTS.....	8
Equipment Operation.....	8
Thermal Marks.....	8
Assessment of Degree of Mixing within a Tender.....	8
Sampling Statistics.....	8
Analyses.....	11
χ^2 test of independence.....	11
Logit analysis.....	12
Comparisons of proportions of marks between strata.....	14
Runs test.....	16
DISCUSSION.....	17
Equipment.....	17
Thermal Marks.....	17
Mixing of Fish within a Tender.....	17
CONCLUSIONS.....	19
LITERATURE CITED.....	20
APPENDICES.....	21

LIST OF TABLES

Table 1. Banding patterns and associated thermal schedules.....	6
Table 2. Marking and sampling scenarios for Events 1 through 3.....	10
Table 3. Found marks for Events 1 through 3.....	11
Table 4. χ^2 and P values for test of independence.....	12
Table 5. Parameter estimates and P values for logit model.....	13
Table 6. Parameter estimates and P values for linear logit model.....	14
Table 7. Estimated proportions of marks and P values for Z -tests.....	15
Table 8. Observed number of runs and P values for H_0 : sequence is random.....	16

LIST OF FIGURES

Figure 1. Thermal Marks on Pink Salmon Otoliths from Four Different Hatcheries in Prince William Sound.....	9
---	---

LIST OF APPENDICES

Appendix A: Technical Specifications for the Design and Construction of Containerized Process Water Heating System.....	21
--	----

EXECUTIVE SUMMARY

This report documents Restoration Study 95320C, one of the projects designed to restore the pink salmon *Oncorhynchus gorbuscha* resource of Prince William Sound (PWS) to its pre-spill status. Water heaters were installed at four hatcheries in PWS; A.F. Koernig, W. H. Noerenberg, Cannery Creek, and Solomon Gulch. Approximately 684.7 million pink salmon embryos had marks applied to their otoliths by a sustained 4°C change in the water temperature for a 24 hour period. Application of hatchery-specific marks will allow separation between hatcheries and between wild stocks when adults return in 1997. To aid in the development of an efficient otolith sampling strategy, a study was undertaken to determine the amount of mixing that occurs in salmon tenders.

INTRODUCTION

Between 1961 and 1976, when hatcheries were absent from Prince William Sound (PWS), the commercial seine harvest of wild pink salmon *Oncorhynchus gorbuscha* averaged about 3.4 million fish. In the early 1970's, run failures led to an aggressive enhancement program which included construction of hatcheries. By 1986 five hatcheries were operating: the Solomon Gulch hatchery, producing pink salmon, and later, chum *O. keta*, coho *O. kisutch* and chinook salmon *O. tshawytscha*, the A. F. Koernig hatchery, producing pink salmon, the W. H. Noerenberg hatchery, producing pink salmon, and later, chum, coho and chinook salmon, the Cannery Creek hatchery, producing pink salmon, and the Main Bay hatchery which produced chum and presently raises sockeye salmon *O. nerka*. From the late 1980's to the present, returns to these facilities have contributed approximately 20 million fish to the annual pink salmon run. Significant numbers of sockeye, coho, chum and chinook salmon have also been produced.

Parent stocks for PWS hatchery production were selected from native populations in the Sound with the consequence that the migratory timings of adult hatchery and wild returns coincided. Furthermore, virtually all these salmon stocks migrate to their natal streams or hatcheries through corridors in the southwestern and western areas of the Sound. The coincident timing and location of the large hatchery return and the considerably smaller wild returns lead to the danger of over-exploitation of the latter by the commercial fishery. Indeed, shortfalls in wild escapements were observed in more than half of the 15 years prior to hatchery production, when the average exploitation rate was 42%, a figure considerably lower than the 60% considered appropriate today for returning hatchery fish.

To protect wild stocks in a hatchery-dominated fishery, managers needed information pertaining to the temporal and spatial distributions of hatchery and wild fish. To meet this requirement, a coded wire tagging (CWT) program was initiated in 1986 for hatchery releases of pink salmon with recovery of tagged returning adults in commercial and cost-recovery fisheries beginning in 1987. Tag recovery data enabled managers to estimate hatchery and wild contributions to catches from temporal and spatial strata within the fishery.

The March 24, 1989, *Exxon Valdez* oil spill exacerbated the problems faced by the fishery manager. The spill contaminated intertidal portions of streams where the majority of wild salmon stocks in western PWS spawn as well as the marine waters traversed by juvenile salmon on their migration seaward through the Sound. Natural Resource Damage Assessment Fish/Shellfish (F/S) studies 2 and 4, demonstrated significant detrimental effects of oil contamination upon pink salmon embryos, pre-emergent fry, and juvenile salmon from wild populations in the Sound. The

decisions made by fishery managers suddenly became more complicated in as far as they affected wild populations injured by the oil spill.

The CWT program was continued through the years following the spill, and was funded under the Natural Resource Damage Assessment study F/S 3 through 1991 (Sharr et al, 1995a). During this period, the program continued to provide information pertaining to the nature of the commercial salmon catch. In 1992, the pink salmon tagging program was supported through Restoration Study R60A (Sharr et al, 1995b) and in 1993 and 1994 through Restoration Study 93067 (Sharr et al, 1995c) along with matching funds from the Prince William Sound Aquaculture Corporation (PWSAC), Valdez Fisheries Development Association (VFDA) and the State of Alaska. In 1995, the program was supported by R95320B, along with matching funds from PWSAC, VFDA, and the State of Alaska.

Hatchery contribution estimates provided by the CWT program are based on several assumptions including the premise that a tagged fish does not behave any differently from its untagged cohorts. In reality, tagged fish likely experience higher mortality rates, and an adjustment factor, based upon tag recoveries from the brood stock, has been used to compensate for this effect and the fact that tags are inevitably shed after implantation. The validity of the adjustment factor corrections are dependent upon the assumption that brood stocks contain only fish reared at the hatchery in question, and that for a given cohort, the tag rate in the brood is equal to that in the commercial fishery. It is thought that these assumptions may be flawed. Immigration of wild fish into the brood stocks is suspected (Sharr et al. 1995c) and Habicht (1996) presents evidence that tags may induce straying, so that marks present in the commercial fishery may not be fully represented in the brood stocks. Identifiable thermal marks have been produced on otoliths of chinook salmon, coho salmon, sockeye salmon, chum salmon, pink salmon and Atlantic salmon (*Salmo salar*) (Munk et al, 1993). It is thought that use of such a non-intrusive mark will eliminate the need for adjustment factors and will result in more accurate and precise estimates of hatchery contributions to the commercial fishery. It is also anticipated that the cost of applying and recovering marks will be less than that of the current CWT program. Otolith marking of all the hatchery pink salmon production was initiated in 1995 with support from R95320C. Two years of marking PWS pink salmon with both thermal marks and CWT's will allow direct comparisons between the two methods and provide insight on the drawbacks and benefits of each type of mark.

This report documents the activities and results of the otolith marking program in 1995 as it pertains to hatchery pink salmon. It focuses primarily upon hatchery equipment installation and mark application.

OBJECTIVES

1. To install and operate a water heating system capable of sustaining a 3.5°C change in incubation water temperature for a minimum of 24 hours.
2. To apply unique and distinct thermal marks to the otoliths of developing pink salmon embryos at all four pink salmon hatcheries in PWS.
3. To determine the amount of mixing of fish that occurs from loading to unloading in salmon tenders.

METHODS

Equipment Purchase and Installation

The water heating system used at all four pink salmon hatcheries in PWS was designed by KCM, Inc. of Seattle, Washington. The design packet was let for bid and was awarded to Ramsett Mechanical of Renton, Washington. The equipment was installed in a containerized van by Ramsett Mechanical. One van was then shipped to each hatchery in the Sound. Hatchery personnel located the van and made all the water, fuel and electrical connections. Once installed, Ramsett Mechanical supplied one inspector to perform a final inspection and test the system. Each van contained two boilers designed to heat process water with flow rates from 50 to 200gpm at temperatures ranging from 1.7 to 9.4°C to a *delta* T of 11.7°C at the maximum process water temperature and at 200 gpm. Additional technical specifications can be found in the Technical Specifications for the Design and Construction of a Containerized Process Water Heating System (Appendix A).

Application of Thermal Marks

Otoliths are composed of three pairs of bones in salmon, the sagittae, lapillae and asteriscae. The sagittae is the bone used for applying thermal marks because of its early development, size and hardness. Thermal marks were applied to hatchery produced pink salmon embryos in PWS after otolith development proceeded beyond the primordial stage, approximately 275 temperature units (1 temperature unit is 1°C above 0°C for 24 h). This development also coincides with what is commonly referred to as the “eyed” stage in salmon egg development. The thermal marking was to be completed prior to egg hatch to eliminate the masking of the mark at hatch and to prevent gas supersaturation problems in the alevins from the heated water.

Thermal marks on otoliths are classified using a “Region, Band, and ring” (RBr) code. The Region (R) of the mark is broken down into 3 parts. Region 1 occurs in that area after the primordial stage and before the hatch mark. Region 2 occurs after the hatch mark and Region 3 describes a thermal mark that occurs in both Region 1 and Region 2. The Band (B) of the mark is composed of one or more rings (r). Generally speaking Bands will have a minimum of three rings as fewer rings often may be overlooked as a normal growth sequence. The ring number describes the number of dark colored rings in a band. The RBr code is written numerically R:B.r and is described schematically (Table 1) as a series of “I’s” (Munk, in process).

Thermal marks were applied to all pink salmon embryos incubated in PWS hatcheries in the fall of 1995. Marks were chosen to distinguish all four hatcheries and to be applicable within the available marking window (Table 1). A suitable thermal mark schedule was devised to provide the chosen marks. Thermal marks were induced by causing rapid temperature declines of 4°C in the incubation water. This decline was accomplished by raising the ambient water temperature for 24 hours and then returning it back to its ambient temperature in repeated cycles until the desired number of rings were applied to the otolith of the fish. Rings are laid down during the temperature decline as the amount and rate of materials being deposited on the otolith are changed (Munk, et al, 1993). Early in the marking schedule when ambient water temperatures were high, the schedule used 24 hour alternating cycles. Later in the season as the ambient temperatures dropped the schedule was modified to 36 hour alternating cycles at Cannery Creek and W.H. Noerenberg hatcheries to insure proper spacing between rings. Solomon Gulch and A.F. Koernig hatcheries had completed their marking prior to the lower ambient temperatures.

Table 1. Banding patterns and associated thermal schedules.

Hatchery	Schedule	R:B.r	Ring pattern
A.F.KOERNIG	(4X)24H:24C	1:1.4	III
CANNERY CREEK	(3X)24H:24C,(1X)72H: 36C,2(X)24H:24C	1:1.3,2.3	III III
W.H. NOERENBERG	(8X)24H:24C	1:1.8	IIIIIII
SOLOMON GULCH	(6X)24H:24C	1:1.6	IIIII

The marking schedules were set up so that the oil-fired boilers ran continuously after a second row of incubators reached the minimum developmental stage needed for marking. The alternating hot and cold cycles were timed to run one row of incubators hot while the second row was running cold. The sequence was reversed for the next 24 hours. This marking schedule allowed for the maximum number of embryos to be marked in the shortest time period.

Determination of the Travel-induced Redistribution of a Localized Collection of Marks within a Tender

Pectoral fin-clipped fish were added to two tenders at the A.F. Koernig hatchery during cost recovery harvests and to one tender at Payday Point in the Unakwik district during a commercial fishery opening. When a suitable tender was identified, a group of three to four technicians flew out to the tender, and removed pectoral fins from approximately 2,000 pink salmon using garden pruning shears. The clipped fish were added *en masse* to the fish hold. Stratified random

samples of the tender loads were subsequently taken from the processing belt at the North Pacific processing plant in Cordova. A lap-top computer using a random-sampling algorithm, was used to indicate when a fish should be selected from the belt and examined for a missing pectoral fin. Data were analyzed using a χ^2 -test of independence, a logit and linear logit analysis and a runs test.

RESULTS

Equipment Operation

All the hatcheries were able to apply their assigned thermal mark to all lots of pink salmon embryos prior to hatching. None of the hatcheries experienced any difficulties with the water heating equipment that would have compromised their assigned mark. All of the hatcheries were able to maintain temperatures from 3.8° to 4.0°C above the ambient temperature when the marking process required it.

Thermal Marks

High quality marks were found in samples taken from each of the four hatcheries three weeks after completion of the marking process (Figure 1). Voucher samples will be taken at the time of emergence from each lot at each hatchery so that any confounding marks laid down during the remaining incubation period will be apparent and documented.

Assessment of Degree of Mixing within a Tender

Sampling Statistics

The following stipulations/assumptions were made regarding the sampling scenario:

- Five strata were to be examined at the processor
- Ten marks were to be found per interval, in the event that marks were randomly distributed
- The number of signals per minute that a sampler could deal with was 10 (Event 1) and 15 (Events 2 and 3)
- The rate of unloading at the processor was 500 (Event 1) and 650 (Events 2 and 3) fish per minute

The above led to a required addition of 2,500 marks to the tender load for Event 1 and 2,166 marks for Events 2 and 3. Circumstances conspired to yield three strata for events 1 and 2 (the unloading rate was underestimated).

Descriptions of the three marking and sampling events are given in Table 2, and results pertaining to found marks in Table 3.

Figure 1. Thermal Marks on Pink Salmon Otoliths from Four Different Hatcheries in Prince William Sound

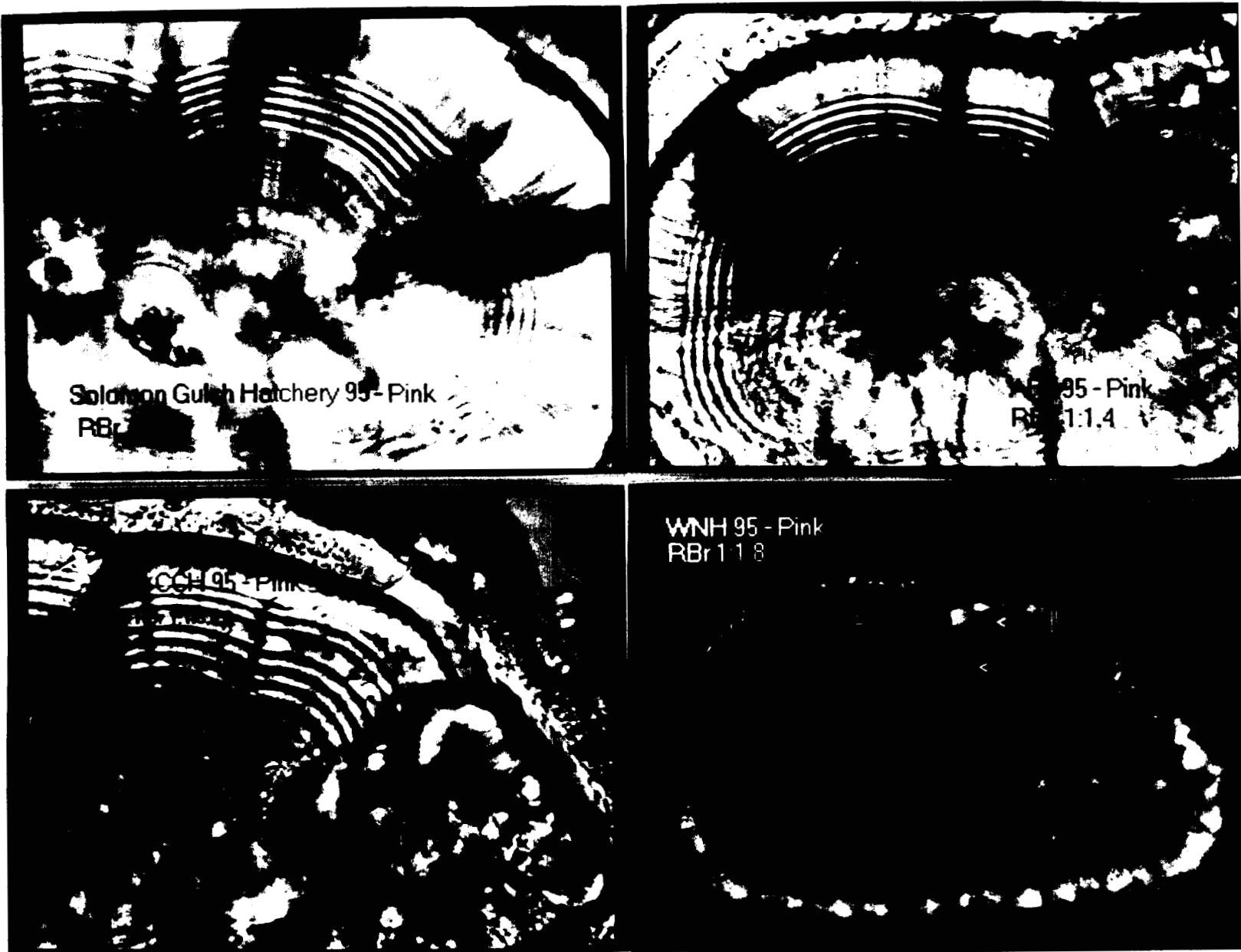

Table 2. Marking and sampling scenarios for Events 1 through 3.

	EVENT		
	1	2	3
Tender Name	Spartan	James A.	Spartan
Load (# fish)	31,805*	43,000	25,820
Loading Site	A.F. Koernig	Payday Point (Unakwik)	A.F. Koernig
# Marks Added	1,948	2,300	2,242
Marks Added after :	27% loading complete	0% loading complete	100% loading complete
Distance to Processor (miles)	85	60	85
Processor	North Pacific	North Pacific	North Pacific
Date of Sampling	08/15/95	08/18/95	08/27/95

* Total load was 45,850 fish, but marked fish only added to one of the fish holds, which contained 31,805 fish.

Table 3. Found marks for Events 1 through 3.

	STRATUM					Total
	I	II	III	IV	V	
Event 1						
Marked	7	12	3			22
Unmarked	168	150	87			405
Total	175	162	90			427
Sampled						
Event 2						
Marked	4	8	18			30
Unmarked	116	110	136			362
Total	120	118	154			392
Sampled						
Event 3						
Marked	15	9	1	4	1	30
Unmarked	78	74	109	91	109	461
Total	93	83	110	95	110	491
Sampled						

Analyses

χ^2 test of independence

A χ^2 -test of independence between the mark variable (two levels, marked and unmarked) and the stratum variable was conducted.. The question addressed was “Is the ratio of marked to unmarked fish independent of the stratum number?”. P values for events 1, 2 and 3 were 0.25, 0.033 and 0, respectively. More detailed results are given in Table 4.

Table 4. χ^2 and P values for test of independence.

	EVENT		
	1	2	3
χ^2	2.8	6.84	30.5
df	2	2	4
P value	0.25	0.033	0

Logit analysis

Two logit models were fitted, with marked/unmarked being the binary response. The first model followed the form:

$$\log \left[\frac{\#Marked_i}{\#Unmarked_i} \right] = \alpha + \beta_i \quad \text{EQ 1}$$

where i indexes stratum number. A full (saturated) and reduced ($\beta_i=0$) model were fitted, and a likelihood ratio test used to determine whether the β_i 's explained a significant amount of variation in the data. The interpretation of, for example, β_{III} for any of Events 1, 2, or 3 under the restrictions ($\beta_i=0$) imposed by GLIM software (Numerical Algorithms Group) is :

$$\beta_{III} = \text{Log} \left[\frac{\frac{\pi_{m,III}}{\pi_{u,III}}}{\frac{\pi_{m,I}}{\pi_{u,I}}} \right] \quad \text{EQ 2}$$

where $\pi_{m,III}$ is the probability of marked fish in stratum III, and $\pi_{u,III}$ is the probability of unmarked fish in stratum III (similarly for stratum I). The parameter β_{III} is thus the log odds ratio for stratum I vs III. A similar interpretation may be made for β_{II} . The model is a general one, in that it allows the existence of two different log-odds ratios. Results are given in Table 5.

Table 5. Parameter estimates and P values for logit model.

	EVENT		
	1	2	3
Parameter Estimates:			
α	-3.178	-3.367	-1.649
β_{II}	0.652	0.746	-0.458
β_{III}	-0.189	1.345	-3.04
β_{IV}	-	-	-1.48
β_V	-	-	-3.04
P value for test	0.259	0.028	0
$H_0: \beta_{II} = \beta_{III} = 0$			

The second model follows the form:

$$\log \left[\frac{\# \text{Marked}_i}{\# \text{Unmarked}_i} \right] = \alpha + \beta X_i \quad \text{EQ 3}$$

where X_i is an ordinal explanatory variable indicating stratum number. The model now fits one parameter to describe differences between strata, and assumes that the log-odds ratio between adjacent strata is constant:

$$\beta = \text{Log} \left[\frac{\frac{\Pi_{m,i+1}}{\Pi_{u,i+1}}}{\frac{\Pi_{m,i}}{\Pi_{u,i}}} \right] \quad \text{EQ 4}$$

The model is a more parsimonious one than the one described in Equation 1), since it has only two parameters. A full and reduced ($\beta=0$) model were fitted, and a likelihood ratio test used to determine whether the linear component explained a significant amount of variation in the data. Results are given in Table 6.

Table 6. Parameter estimates and P values for linear logit model..

		EVENT		
		1	2	3
Parameter Estimates:				
	α	-2.969	-3.98	-0.909
	β	0.031	0.656	-0.732
P value for test $H_0: \beta=0$		0.91	0.007	0

Comparisons of proportions of marks between strata

The sample size in each stratum was considered large enough, and the ratio of sample to total catch small enough that the calculated proportions could be assumed to be normally distributed. Z -tests of differences (number of strata-1 orthogonal comparisons) in proportions between strata were therefore considered appropriate. The results are given in Table 7.

Table 7. Estimated proportions of marks and P values for Z-tests.

	STRATUM				
	I	II	III	IV	V
Event 1 Estimated proportions	0.04	0.074	0.033	-	-
P value for H_0 : Proportion in Stratum I = Proportion in Stratum j					
	I	II	III	IV	V
	-	0.179	0.780	-	-
Event 2 Estimated proportions	0.033	0.068	0.117	-	-
P value for H_0 : Proportion in Stratum I = Proportion in Stratum j					
	I	II	III	IV	V
	-	0.223	0.0063	-	-
Event 3 Estimated proportions	0.161	0.108	0.009	0.042	0.009
P value for H_0 : Proportion in Stratum I = Proportion in Stratum j					
	I	II	III	IV	V
	-	0.299	<0.0061	0.0061	<0.0061

Runs test

Here the number of runs (in the sequence marked, marked, unmarked, unmarked, marked, marked, there are three runs) in the sample is compared to the number expected in a random sequence of marked and unmarked fish. While large-sample Z-tests are available for such a comparison, simulations revealed that distributions of the number of runs under the null hypothesis of random sequences were fairly non-normal for the combinations of marked and unmarked fish present in this study. *P* values were obtained using simulated empirical distributions of the number of runs in random sequences. The results are presented in Table 8.

Table 8. Observed number of runs and *P* values for H_0 : sequence is random.

	EVENT		
	1	2	3
Observed number of runs	43	55	55
<i>P</i> value for test H_0 : Sequence is random	0.71	0.39	0.28

DISCUSSION

Equipment

All equipment purchased and installed proved to be adequate to thermally mark all the pink salmon embryos at all four PWS hatcheries, thus meeting Objective 1. The heated water was able to maintain close to a 4°C rise in temperature over ambient for the prescribed amount of time. The systems required little maintenance or repair in this first year of operation with the exception of some minor initial problems encountered at the Cannery Creek and Solomon Gulch hatcheries.

Thermal Marks

High quality marks are one of the prerequisites to the successful implementation of an otolith marking program intended to separate hatchery and wild stocks. Preliminary sampling of otoliths indicates that such marks were indeed placed on the otoliths of all pink salmon embryos produced by PWS hatcheries. While further voucher samples will yield a more detailed view of the nature and success of the marking process, it currently appears that the goals outlined in Objective 2 have been met.

Mixing of Fish within a Tender

For the events where marked fish were added at either the beginning or the end of the load (events 2 and 3, respectively), strong evidence was found to indicate that added marks were clustered within the hold of the tenders upon unloading at the processor. The χ^2 , logit, linear logit and z-test analyses all led to strong rejection of the hypothesis that marks were evenly distributed throughout the load. The runs test did not reject the hypothesis. Non-parametric tests are notoriously weak, and it is suggested that this is the reason for the inability of the runs tests to identify any effect. The linear logit β parameter explained a significant amount of variation for both events. This is consistent with the notion that there was an incomplete mixing, with the result that the number of marks appearing on the processing belt decreased as fish were pumped from sections of the tender distant from the location to which the marks were added. The signs of the estimates of the linear logit parameters are also consistent with the mark-loading scenario. For event 2, where marks were added at the beginning of the load, the estimate of β is +0.656, which makes sense in that it estimates that the odds for marked fish versus unmarked fish for stratum III is almost twice that of stratum II, which is twice that of stratum I. For event 3, where

marks were added at the end of the loading process, the estimate of β is -0.732. Also of interest is that these estimates are of similar magnitude, suggesting that the degree of mixing is similar for both tenders. Fish appear to mix equally in both directions, bottom to top and top to bottom.

No evidence was found from event 1 to indicate that marks were clustered in the hold of the tender. It is suggested that this is because marks were added to the middle of the load, and some mixing occurred in both directions. The load therefore appeared mixed at the processor.

The relevance of the above to the design of otolith-sampling schemes is that it appears that we cannot rely on tender travel to efficiently mix loads. Tenders themselves may be heavily stratified if they receive, for example, predominantly wild fish at the beginning of the loading process, and hatchery fish towards the end. It seems that systematic samples taken from one section of the load may be biased, and that to achieve a representative sample, some sort of stratified sampling will be required from each tender.

CONCLUSIONS

The major objective of this project was to thermally mark all hatchery produced pink salmon in a manner that would allow the separation of hatchery produced fish between hatcheries and between wild stocks. The samples taken three weeks postmark indicate that unique high quality marks were applied using the equipment purchased and installed in 1995 at the four PWS pink salmon hatcheries. With respect to catch-sampling strategies, it appears that a tender cannot be relied upon to efficiently mix a load to the extent that systematic samples can be assumed to mimic, even distantly, random samples. It is apparent that any sampling strategy should sample otoliths throughout the unloading process.

LITERATURE CITED

- Habicht, C., S. Sharr, and J.E. Seeb. 1996. Coded wire tag placement affects homing precision of pink salmon. *In press*.
- Munk, K.M., W.W. Smoker, D.R. Beard, and R.W. Mattson. 1993. A hatchery water-heating system and its application to 100% thermal marking of incubating salmon. *The Progressive Fish-Culturist*. 55:284-288.
- Munk, K.M., (*in process*), Thermal Marking Manual: A guideline to the induction of thermal marks in otoliths for the purpose of mass-marking hatchery stocks. Alaska Department of Fish and Game, Special Publication, Juneau.
- Sharr, S., T.M. Willette, C.J. Peckham, D.G. Sharp, J.L. Smith, D.G. Evans, and B.G. Bue. 1995a. Coded wire tag studies on Prince William Sound salmon. Natural Resource Damage Assessment Fish/Shellfish Study Number 3, Alaska Department of Fish and Game, Cordova.
- Sharr, S., C.J. Peckham, D.G. Sharp, J.L. Smith, D.G. Evans, and B.G. Bue. 1995b. Coded wire tag studies on Prince William Sound salmon. Natural Resource Damage Assessment Restoration Study Number R60A, Alaska Department of Fish and Game, Cordova.
- Sharr, S., C.J. Peckham, D.G. Sharp, J.L. Smith, D.G. Evans, and B.G. Bue. 1995c. Stock identification of chum, sockeye, coho and chinook salmon in Prince William Sound. Natural Resource Damage Assessment Restoration Project 93068, Alaska Department of Fish and Game, Cordova.

APPENDICES

*Appendix A: Technical Specifications for the Design and Construction of
Containerized Process Water Heating System*

PRINCE WILLIAM SOUND AQUACULTURE CORPORATION

PWSAC

TECHNICAL SPECIFICATIONS
FOR THE
DESIGN AND CONSTRUCTION OF A
CONTAINERIZED PROCESS WATER HEATING SYSTEM

February 1995

by

KCM

KCM, Inc.
230 South Franklin
Suite 204
Juneau, AK 99801-1364

Project: PWSAC Containerized Process Water Heating Systems

Bid Submitted to: Prince William Sound Aquaculture Corporation

c/o KCM, Inc.
1917 First Avenue
Seattle, Washington 98101
Attention: Barry Scott
Telephone: (206)443-5377
Fax: (206)443-5372

Bids to Submitted on or before: February 23, 1995 at 2:00 PM Pacific Standard Time

1. The undersigned Bidder proposes and agrees, if this Bid is accepted, to enter into an Agreement with the Owner in a form to be agreed upon to complete all work as specified or indicated in the contract documents for the contract price and within the contract time indicated in this Bid and in accordance with the contract documents. A Performance and Payment Bond (in a form to be agreed upon) will be required.

2. The Bidder shall insert unit bid price or a lump sum price in figures and in words opposite each pay item for which an estimated quantity appears in the Bid Form. A unit bid price or lump sum bid price is not to be entered or tendered for any pay item for which no estimated quantity appears in the Bid Form. The estimated quantity of Work for payment on a lump sum basis will be "all required".

Notice: Contract award will be made on the basis of the Total Amount of Basic Bid, or the Total Amount of Basic Bid plus the Total Amount of Bid Alternative No. 1. Owner reserves the right to award the Basic Bid, or the Basic Bid plus Bid Alternative No. 1, or to reject all bids.

BASIC BID

Pay Item No.	Pay Item Name Lump Sum Bid Price Written in Words	Amount Bid
001 Lump Sum All Required	One (1) Complete Containerized Process Water Heating System, for Solomon Gulch Hatchery (SGH) Delivered to Valdez, Alaska on or before June 1, 1995 at _____ _____ (amount in words)	\$ _____
002 Lump Sum All Required	One (1) Complete Containerized Process Water Heating System, for W. Noerenberg Hatchery (WNH) Delivered to Whittier, Alaska on or before June 15, 1995 at _____ _____ (amount in words)	\$ _____
003 Lump Sum All Required	One (1) Complete Containerized Process Water Heating System, for A. F. Koernig Hatchery (AFK) Delivered to Whittier, Alaska on or before June 15, 1995 at _____ _____ (amount in words)	\$ _____
004 Lump Sum All Required	One (1) Complete Containerized Process Water Heating System, for Cannery Creek hatchery (CCH) Delivered to Whittier, Alaska on or before June 15, 1995 at _____ _____ (amount in words)	\$ _____
	TOTAL AMOUNT OF BASIC BID:	\$ _____

BID ALTERNATIVE NO. 1

Pay Item No.	Pay Item Name Lump Sum Bid Price Written in Words	Amount Bid
005 Lump Sum All Required	One 91) Complete Process Water Heating System, for Solomon Gulch Hatchery (SGH) Delivered to Valdez, Alaska on or before June 1, 1995, skid-mounted as specified herein in lieu of the containerized unit provided for in the Basic Bid (Check Deduct or Add below) _____ DEDUCT FROM ITEM 001 FROM THE BASIC BID _____ ADD TO ITEM 001 FROM THE BASIC BID at _____ _____ (amount in words)	(\$ _____) Deduct \$ _____ Add
TOTAL AMOUNT OF BID ALTERNATIVE NO. 1: (\$ _____) Deduct \$ _____ Add		

3. Unless otherwise stated in the Bid Form, it will be assumed by the Owner that the bidder has accepted without reservation or amendment the whole of the contract documents. At a bidder's discretion, a Bid may be conditioned upon such qualifications of or amendments to the contract documents as do not materially change the requirements contained therein. Such qualifications or amendments shall be fully described on the form provided herewith. The Owner reserves the right to accept or reject any other qualifications or amendments and to consider price variations thereof (if any) in determining the lowest responsible bid.

4. When the SGH heating system is delivered to Valdez, Alaska the ownership of the system will transfer from PWSAC to the Valdez Fisheries Development Association (VFDA). All maintenance and guarantee work requests for the SGH system will come from VFDA. The remaining three containerized heating systems will remain under the ownership of PWSAC.

5. In the event that Bid Alternate No. 1 is awarded, the contractor shall be fully responsible for shipment of the skid-mounted system to SGH such that the system arrives complete, intact, undamaged and suitable for installation in a room provided by others. VFDA will be responsible for provision of an appropriate and adequate room for the system at SGH.

Submitted on: _____ Day of _____, 1995

Name of Bidding Firm: _____

If Bidder is an Individual:

Submitted by : _____
(Signature)

Business Address: _____

Telephone No: _____

Business License No: _____

If Bidder is a Partnership:

Submitted by : _____
(Signature)

Name: _____

Title: _____ General Partner _____

Business Address: _____

Telephone No: _____

Business License No: _____

If Bidder is a Corporation:

Submitted by : _____
(Authorized Signature)

Name: _____

Title: _____

State of Incorporation: _____

Business Address: _____

Telephone No: _____

Business License No: _____

HEAT EXCHANGER HX-01

PROCESS WATER SUPPLY AND RETURN (TERMINATE 1'-0" FROM CEILING)

CIRCULATING PUMPS

CONTROL PANEL

UNIT HEATER

FUEL OIL SUPPLY (TERMINATE 1'-0"± FROM CEILING)

CEILING EXHAUST STACK PROVIDE FOR FIELD PENETRATION

EXPANSION TANK ET-01

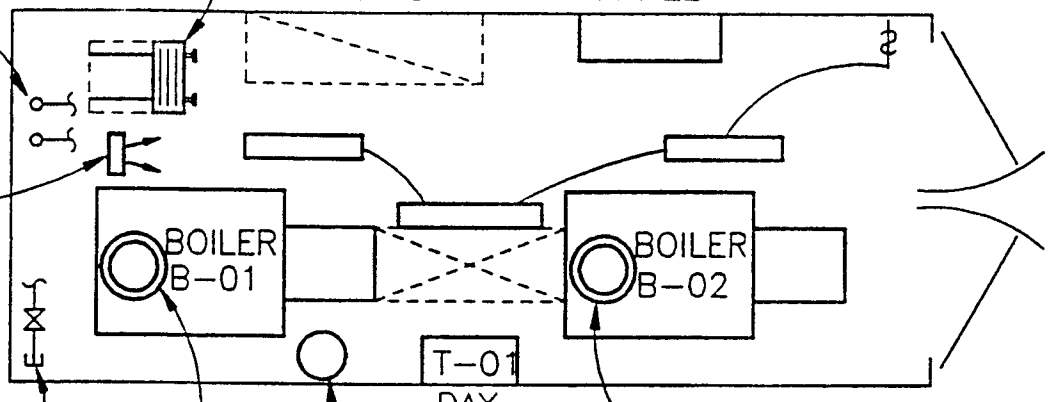

SGH PLAN (BID ITEM 001)

1/4" = 1'-0"

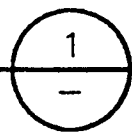

NOTES:

1. PLAN SHOWN FOR CONCEPT ONLY. CONTRACTOR TO MODIFY PLAN TO ACCOMODATE THEIR PROPOSED EQUIPMENT. LAYOUT TO COMPLY WITH ALL APPLICABLE CODES.
2. CONTAINER SHALL BE CLEARLY MARKED WITH IDENTIFICATION CODE SGH.

50011F01 1-48 2450011 1/20F



PRINCE WILLIAM SOUND
AQUA CORP, PWSAC

CONTAINERIZED
HEATING SYSTEM

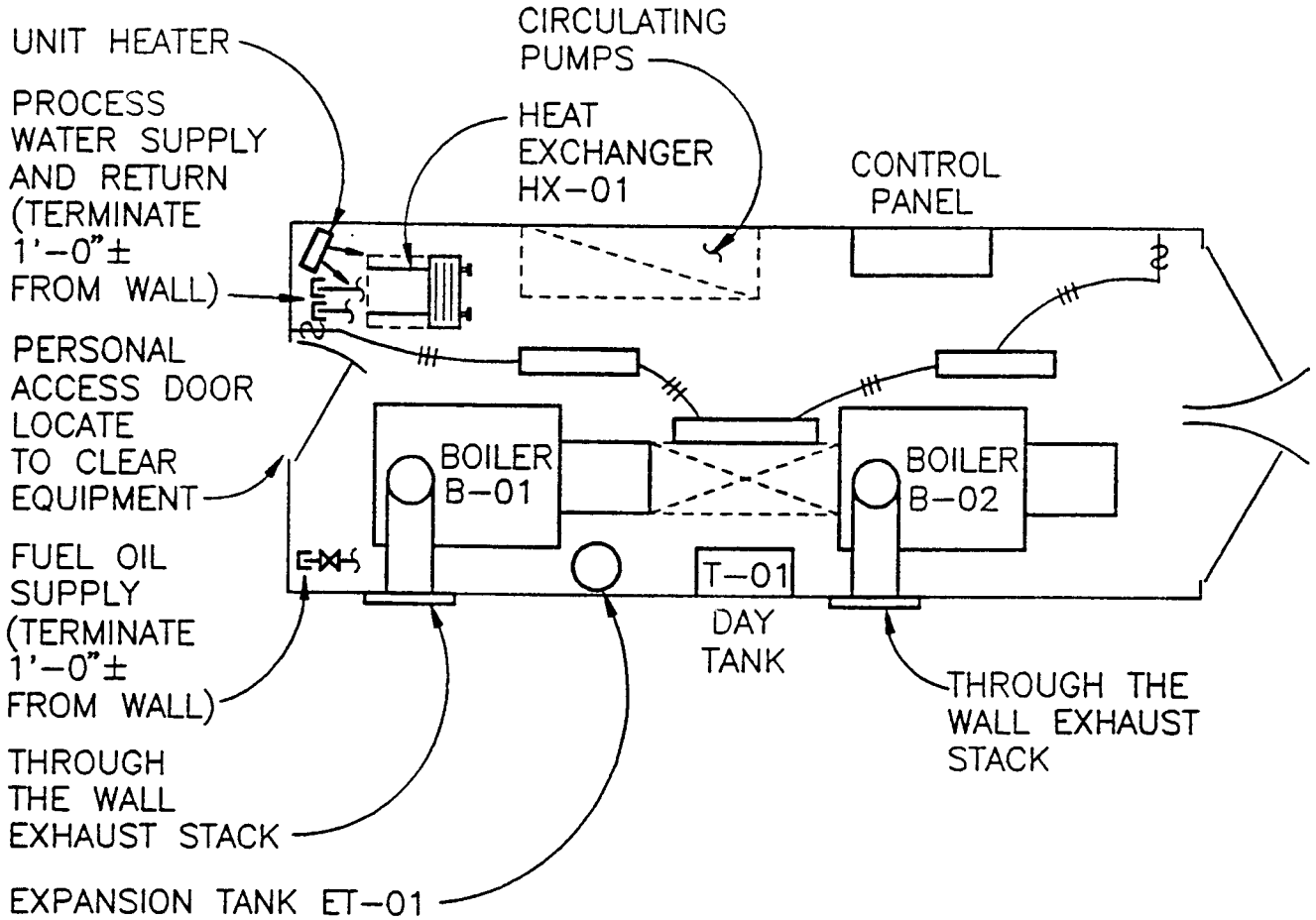

WNH PLAN (BID ITEM 002)

1/4" = 1'-0"

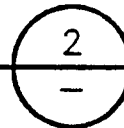

NOTES:

1. PLAN SHOWN FOR CONCEPT ONLY. CONTRACTOR TO MODIFY PLAN TO ACCOMODATE THEIR PROPOSED EQUIPMENT. LAYOUT TO COMPLY WITH ALL APPLICABLE CODES.
2. CONTAINER SHALL BE CLEARLY MARKED WITH IDENTIFICATION CODE WNH.

50011F03.1-48 2450011 1/20

KCM

PRINCE WILLIAM SOUND
AQUA CORP, PWSAC

CONTAINERIZED
HEATING SYSTEM

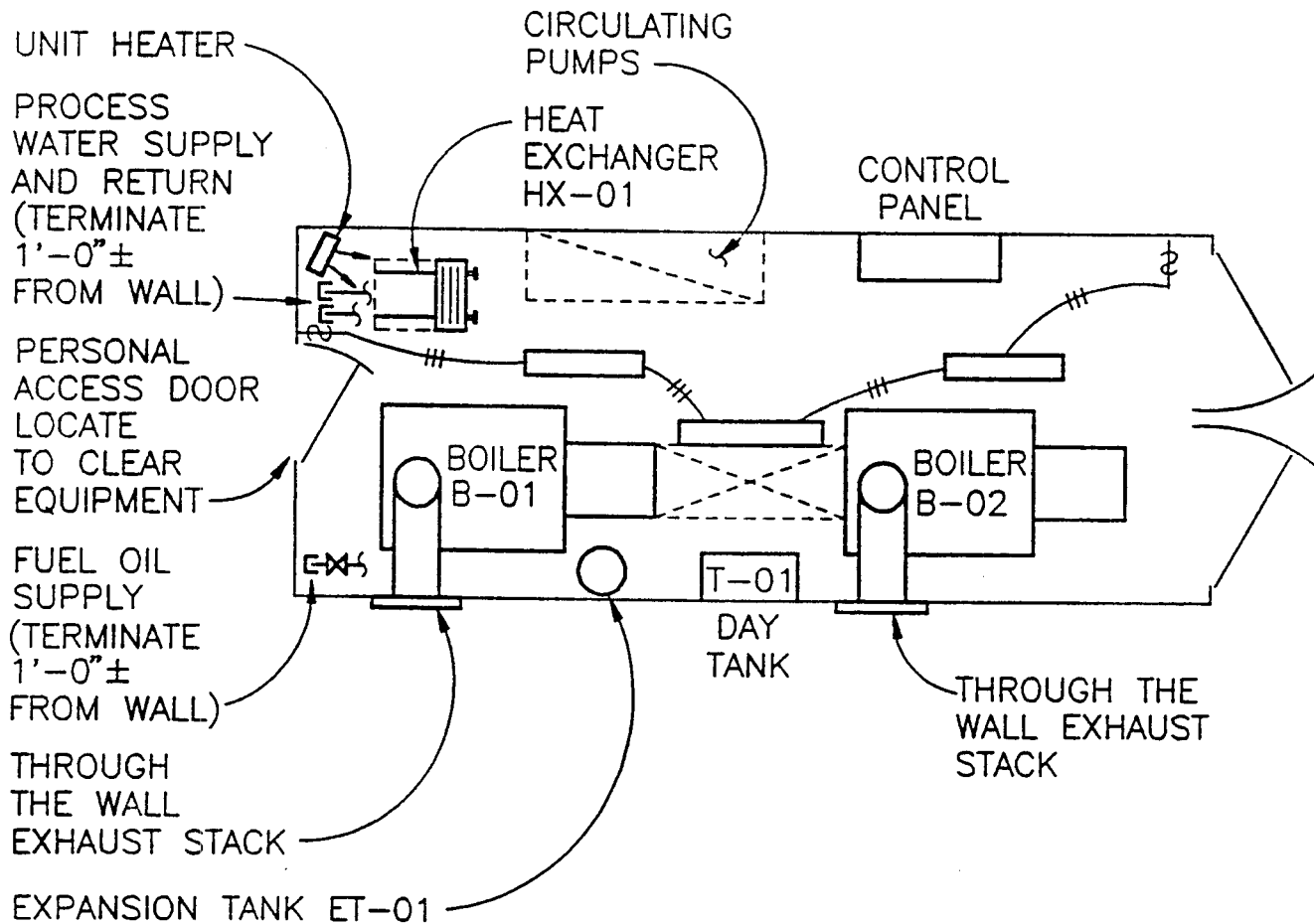

AFK PLAN (BID ITEM 003)

1/4" = 1'-0"

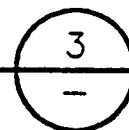

NOTES:

1. PLAN SHOWN FOR CONCEPT ONLY. CONTRACTOR TO MODIFY PLAN TO ACCOMODATE THEIR PROPOSED EQUIPMENT. LAYOUT TO COMPLY WITH ALL APPLICABLE CODES.
2. CONTAINER SHALL BE CLEARLY MARKED WITH IDENTIFICATION CODE AFK.

50011F04 1-48 2450011 1/20F



PRINCE WILLIAM SOUND
AQUA CORP, PWSAC

CONTAINERIZED
HEATING SYSTEM

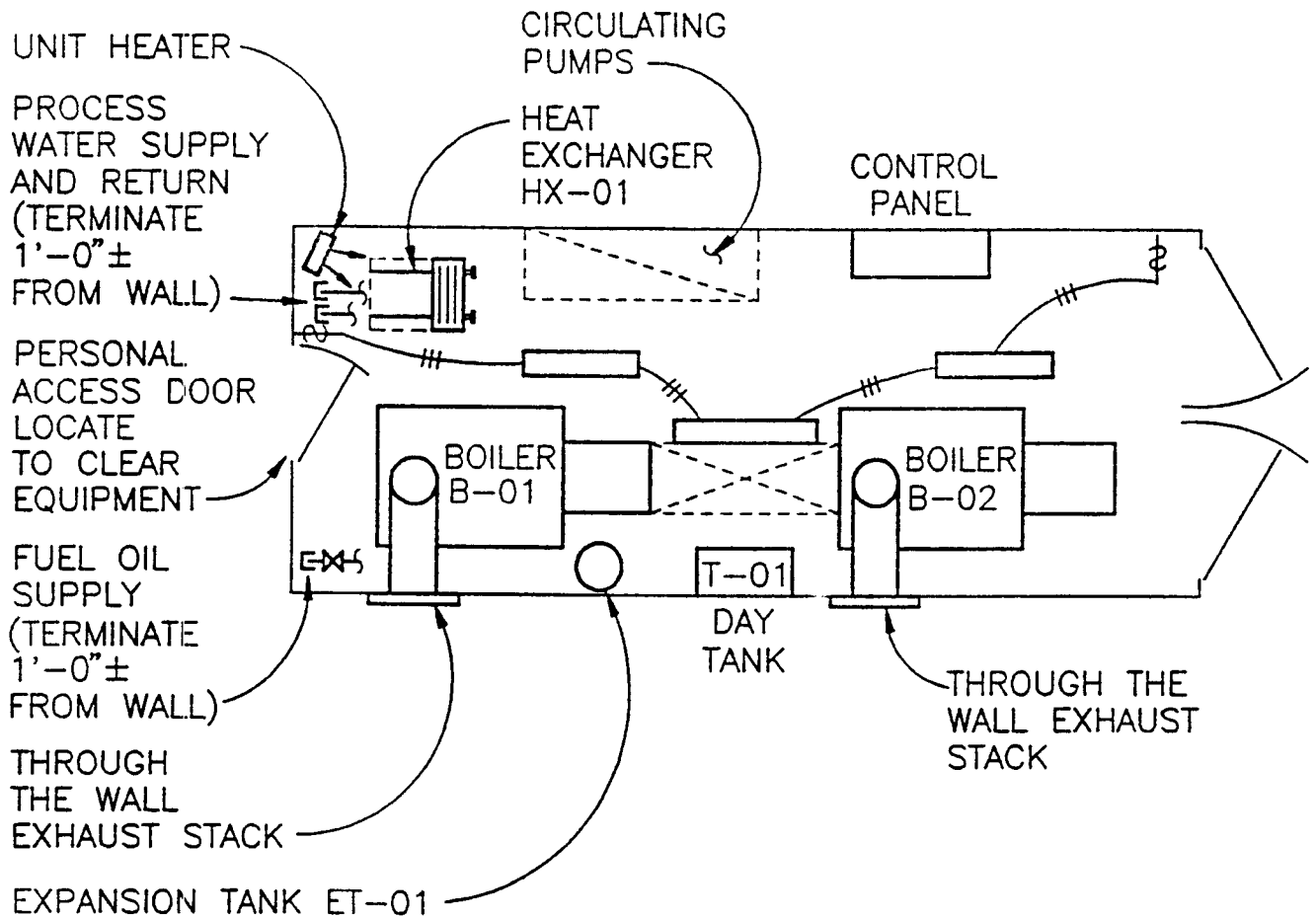

CCH PLAN (BID ITEM 004)

1/4" = 1'-0"

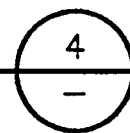

NOTES:

1. PLAN SHOWN FOR CONCEPT ONLY. CONTRACTOR TO MODIFY PLAN TO ACCOMODATE THEIR PROPOSED EQUIPMENT. LAYOUT TO COMPLY WITH ALL APPLICABLE CODES.
2. CONTAINER SHALL BE CLEARLY MARKED WITH IDENTIFICATION CODE CCH.

50011FAA 1-48 2450011 2/75

KCM

PRINCE WILLIAM SOUND
AQUA CORP, PWSAC

CONTAINERIZED
HEATING SYSTEM

KCM

PRINCE WILLIAM SOUND
AQUA CORP, PWSAC

CONTAINER HEATING
SYSTEM

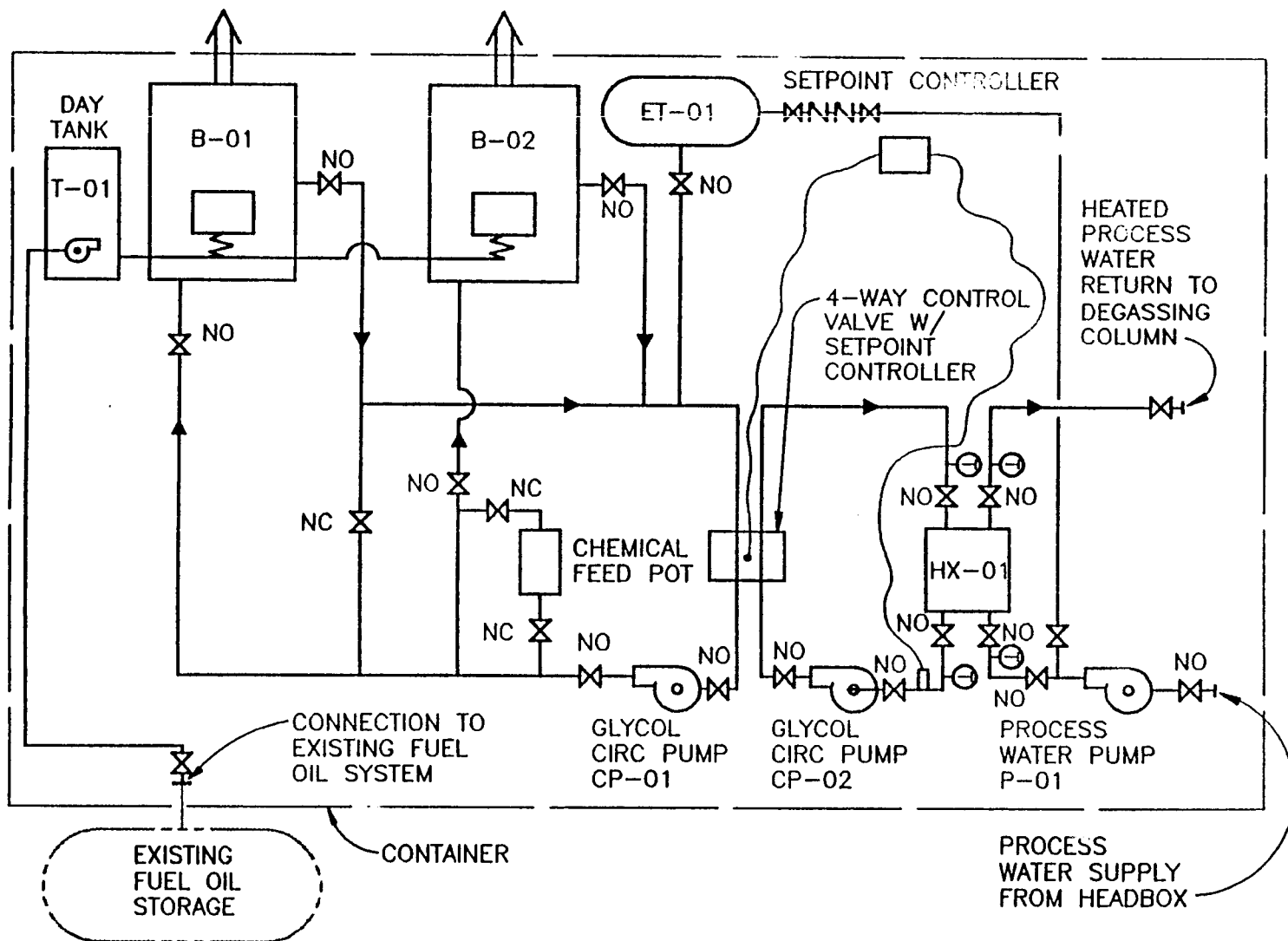

PROCESS FLOW SCHEMATIC

NO SCALE

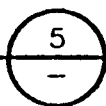

1. GENERAL

A LIST OF ARTICLE TITLES

1.01 SUBMITTAL REQUIREMENTS

1.02 SCHEDULE

1.03 DETAILED BREAKDOWN OF LUMP SUM PRICES

1.01 SUBMITTAL REQUIREMENTS

- A. General: All submittals shall be identified by project title, hatchery name, and number and shall include Contractor's name, date and revision date. In addition, shop drawings, product data and samples shall include names of subcontractor and supplier, applicable specification section number and Contractor's stamp, initialed or signed, certifying to review of submittal, verification of field measurements and compliance with contract documents.
1. All submittals shall be accompanied by a submittal transmittal form. Equipment numbers shall be listed for items being submitted. A separate form shall be used for each specific item, class of material, equipment, and items specified in separate, discrete sections, for which the submittal is required. Submittals for various items shall be made with a single form when the items taken together constitute a manufacturer's package or are so functionally related that expediency indicates checking or review of the group or package as a whole.
 2. A unique number, sequentially assigned, shall be noted on the transmittal form accompanying each item submitted. Original submittal numbers shall have the following format: "XXX"; where "XXX" is the sequential number assigned by the Contractor. Resubmittal shall have the following format: "XXX-Y"; where "XXX" is the originally assigned submittal number and "Y" is a sequential letter assigned for resubmittals; i.e., A, B, or C being the 1st, 2nd, and 3rd resubmittals, respectively. Submittal 25B, for example, is the second resubmittal of Submittal 25.
 3. Submittal Completeness: Submittals which do not have all the information required to be submitted are not acceptable and will be returned without review.
- B. Shop drawings: Submit 5 copies of each shop drawing required by the specifications. Show the information, dimensions, connections and other details necessary to ensure that

the shop drawings accurately interpret the contract documents. show adjoining work in such detail as required to indicate proper connections. Where adjoining connected work requires shop drawings or product data, submit such information for review at the same time so that connections can be accurately checked.

- C. Product data: Submit 5 copies of each item of product data required by the specifications. Modify product data by deleting information which is not applicable to the project or by marking each copy to identify pertinent products. Supplement standard information, if necessary, to provide additional information applicable to project.
- D. Review Procedure: Unless otherwise specified, the Engineer will review the submittal. The returned submittal will indicate one of the following actions:
1. If the review indicates that the material, equipment, or work method is in general conformance with the design concept and complies with the Drawings and specifications, submittal copies will be marked "NO EXCEPTION TAKEN" and given review action 1. In this event the Contractor may begin to implement the work method or incorporate the material or equipment covered by the submittal.
 2. If the review indicates that limited corrections are required, copies will be marked "NOTE MARKINGS" and given review action 2. The Contractor may begin implementing the work method or incorporating the material and equipment covered by the submittal in accordance with the noted corrections. Where submittal information will be incorporated in O&M data, a corrected copy shall be provided, otherwise no further action is required.
 3. If the review reveals that the submittal is insufficient or contains incorrect data, copies will be marked "COMMENTS ATTACHED". If the comments are of a nature that can be confirmed without a resubmittal, copies will be further marked "CONFIRM" and given review action 3. If the comments require a revision and resubmittal, copies will be further marked "RESUBMIT" and given review action 4. Except at its own risk, the Contractor shall not undertake work covered by this submittal until the attached comments have been either confirmed by a separate written communication or the submittal has been revised, resubmitted and returned marked with "NO EXCEPTIONS TAKEN" or "NOTE MARKINGS".
 4. If the review indicates that the material, equipment, or work method is not in general conformance with the

design concept or in compliance with the Drawings and specifications, copies of the submittal will be marked "REJECTED" and given review action 5. Except at its own risk, the Contractor shall not undertake work covered by such submittals until a new submittal is made and returned marked either "NO EXCEPTIONS TAKEN" or "NOTE MARKINGS".

- E. Effects of Review of Contractor's Submittals: Review of Drawings, method of work, or information regarding materials or equipment the Contractor proposes to provide, shall not relieve the Contractor of its responsibility for errors therein and shall not be regarded as an assumption of risks or liability by the Engineer on behalf of the Owner, and the Contractor shall have no claim under the Contract on account of the failure, or partial failure, of the method of work, material, or equipment so reviewed. A mark of "NO EXCEPTIONS TAKEN" or "NOTE MARKINGS" shall mean that the Engineer has no objection to the Contractor, upon the Contractor's own responsibility, using the plan or method of work proposed, or providing the materials or equipment proposed.

1.02 SCHEDULE

- A. The Contractor shall provide the following schedule and submit them not later than 15 days after notice to proceed.
1. Contractor's construction schedule:
 - a. The Contractor will be required to prepare and submit to the Engineer for review an overall construction schedule covering all work to be performed.
 - b. The construction schedule shall include, but not be limited to the following item:
 - 1) Shop drawing receipt from Contractor, submitted to Engineer, review and return to Contractor.
 - 2) Material and equipment order, delivery and installation and check-out.
 - 3) Piping installation.
 - 4) Final cleanup.
 - 5) Testing activities.
 - 6) Start-up at site.

- c. The Contractor will be required to accept the risk of any delays caused by the rate of progress of the work to be performed under the above contract, and that in the event the Contractor is delayed in the prosecution and completion of his work because of such conditions, he shall have no claim for damages or contract adjustment.

1.03 DETAILED BREAKDOWN OF LUMP SUM PRICES

- A The Contractor shall, within 15 days of receipt of the notice to proceed, submit a breakdown of the lump sum price.

END OF SECTION

1. GENERAL

A LIST OF ARTICLE TITLES

- 1.01 WRITTEN GUARANTEES
- 1.02 FIELD TESTS AND ADJUSTMENTS
- 1.03 PROJECT RECORD DRAWINGS (AS-BUILT)

1.01 WRITTEN GUARANTEES

A Written guarantees, in duplicate, addressed to each Owner, but submitted to the Engineer.

- 1. Guarantee by Contractor: Guarantee by Contractor covering the entire work for the 1-year period from date of certificate of substantial completion as specified hereinbefore. Letter to be substantially as follows:

(Re: Project)

(Owner) (Address)

Gentlemen:

"I (We) the undersigned do hereby guarantee for a period of one year(s) from date of certificate of substantial completion all work performed under the terms of the contract documents. I (We) will remedy at my (our) expenses any defects appearing during that period due to poor materials or workmanship and will pay for any damage to other work resulting from occurrence of said defects or the correction of same.

This guarantee shall not be interpreted as holding the Contractor responsible for any deterioration of the work due to normal use or the abuse of the work by the Owner.

Very truly yours,

_____ Contractor

- 2. A guarantee bond for the face value of the contract shall be provided to the owner for the one-year guaranteed period."

1.02 FIELD TESTS AND ADJUSTMENTS

A. All mechanical and electrical equipment shall be tested by the Contractor to the satisfaction of the Engineer before unit

is shipped. Tests shall be made to determine whether the equipment has been properly assembled, aligned and connected. Any changes, adjustments or replacements required to make the equipment operate as specified shall be carried out by the Contractor as part of the work.

- B. During the testing of the mechanical, instrumentation, and electrical equipment, the Contractor shall make available as necessary representatives of the manufacturers of all the various pieces of equipment or other qualified persons who shall instruct the Owner's personnel in the operation and care thereof. Instructions shall include written step-by-step operation and troubleshooting procedures with a complete description of all necessary test equipment and all protective device settings.

1.03 PROJECT RECORD DRAWINGS (AS-BUILT)

- A. Maintenance: Maintain, at the jobsite, one set of the contract drawings for recording as-built conditions. Mark (in red) changes made during the course of construction.
- B. Completion of work: Upon completion of the work, turn over the one marked-up set of prints to the Engineer.
- C. Partial payment: Requests for partial payment will not be approved if the marked-up prints are not kept current and request for final payment will not be approved until the marked-up prints are delivered to the Engineer.

END OF SECTION

1. GENERAL

A. LIST OF ARTICLE TITLES

- 1.01 DESCRIPTION OF WORK
- 1.02 QUALITY ASSURANCE
- 1.03 FORM OF SUBMITTALS
- 1.04 CONTENT OF MANUAL
- 1.05 MANUAL FOR EQUIPMENT AND SYSTEMS
- 1.06 SUBMITTAL SCHEDULE

1.01 DESCRIPTION OF WORK

- A. For each containerized system compile product data and related information appropriate for Owner's maintenance and operation of products furnished under the contract.
 - 1. Prepare operating and maintenance data as specified in this section and as referenced in other pertinent sections of specifications.
- B. Instruct Owner's personnel in the maintenance of products and in the operation of equipment and systems.

1.02 QUALITY ASSURANCE

- A. Preparation of data shall be done by personnel:
 - 1. Trained and experienced in maintenance and operation of the described products.
 - 2. Completely familiar with requirements of this section.
 - 3. Skilled as a technical writer to the extent required to communicate essential data.
 - 4. Skilled as a draftsman competent to prepare required drawings.

1.03 FORM OF SUBMITTALS

- A. Prepare data in the form of an instructional manual for use by Owner's personnel.
- B. Format
 - 1. Size: 8-1/2 inches by 11 inches
 - 2. Paper: 20-pound minimum, white, for typed pages.

3. Text: Manufacturer's printed data, or neatly type-written.
4. Drawings:
 - a. Provide reinforced punched binder tab, bind in with text.
 - b. Fold larger drawings to the size of the text pages.
5. Provide fly-leaf for each separate product, or each piece of operating equipment.
 - a. Provide typed description of product, and major component parts of equipment.
 - b. Provide indexed tabs.
6. Cover: Identify each volume with typed or printed title "Operating and Maintenance Instruction." List:
 - a. Title of project.
 - b. Identity of separate structure as applicable.
 - c. Identity of general subject matter covered in the manual.

C. Binders

1. Binders shall be similar and equal to National 98-381.

1.04 CONTENT OF MANUAL

- A. Neatly typewritten table of contents for each volume, arranged in a systematic order.
 1. Contractor, name of responsible principal, address and telephone number.
 2. A list of each product required to be included, indexed to the content of the volume.
 3. List with each product, the name, address and telephone number of:
 - a. Subcontractor or installer.
 - b. Maintenance contractor, as appropriate.
 - c. Identify the area of responsibility of each.
 - d. Local source of supply for parts and replacement.

4. Identify each product by product name and other identifying symbols as set forth in contract documents.
- B. Product data
1. Include only those sheets which are pertinent to the specific product.
 2. Annotate each sheet to:
 - a. Clearly identify the specific product or part installed.
 - b. Clearly identify the data applicable to the installation.
 - c. Delete references to inapplicable information.
- C. Drawings
1. Supplement product data with drawings as necessary to clearly illustrate:
 - a. Relations of component parts of equipment and systems.
 - b. Control and flow diagrams.
 2. Coordinate drawings with information in project record documents to assure correct illustration of completed installation.
 3. Do not use project record documents as maintenance drawings.
- D. Written text, as required to supplement product data for the particular installation.
1. Organize in a consistent format under separate headings for different procedures.
 2. Provide a logical sequence of instruction for each procedure.
- E. Copy of each warranty, bond and service contract issued.
1. Provide information sheet for Owner's personnel, give:
 - a. Proper procedures in the event of failure.
 - b. Instances which might affect the validity of warranties or bonds.

1.05 MANUAL FOR EQUIPMENT AND SYSTEMS

- A. Submit 3 copies of complete manual in final form for each containerized system (12 total).
- B. Content, for each unit of equipment and system, as appropriate:
 - 1. Description of unit and component parts.
 - a. Function, normal operating characteristics, and limiting conditions.
 - b. Performance curves, engineering data and tests.
 - c. Complete nomenclature and commercial number of all replaceable parts.
 - 2. Operating procedures:
 - a. Start-up, break-in, routine and normal operating instructions.
 - b. Regulation, control, stopping, shut-down and emergency instructions.
 - c. Summer and winter operating instructions.
 - d. Special operating instructions.
 - 3. Maintenance procedures:
 - a. Routine operations.
 - b. Guide to "trouble-shooting."
 - c. Disassembly, repair and reassembly.
 - d. Alignment, adjusting and checking.
 - 4. Servicing and lubrication schedule:
 - a. List of lubricants required.
 - 5. Manufacturer's printed operating and maintenance instructions.
 - 6. Description of sequence of operation by control manufacturer.
 - 7. Original manufacturer's parts list, illustrations, assembly drawings and diagrams required for maintenance.
 - a. Predicted life of parts subject to wear.

- b. Items recommended to be stocked as spare parts.
 - 8. As-installed control diagrams by controls manufacturer.
 - 9. List of original manufacturer's spare parts, manufacturer's current prices, and recommended quantities to be maintained in storage.
- C. Content, for each electric and control system, as appropriate.
- 1. Description of system and component parts.
 - a. Function, normal operating characteristics, and limiting conditions.
 - b. Performance curves, engineering data and tests.
 - c. Complete nomenclature and commercial number of replaceable parts.
 - 2. Circuit directories of panelboards.
 - a. Electrical service.
 - b. Controls.
 - c. Communications.
 - 3. As-installed color coded wiring diagrams.
 - 4. Operating procedures:
 - a. Routine and normal operating instructions.
 - b. Sequences required.
 - c. Special operating instructions.
 - 5. Maintenance procedures:
 - a. Routine operations.
 - b. Guide to "trouble-shooting."
 - c. Disassembly, repair and reassembly.
 - d. Adjustment and checking.
 - 6. Manufacturer's printed operating and maintenance instructions.

7. List of original manufacturer's spare parts, manufacturer's current prices, and recommended quantities to be maintained in storage.
 8. Other data as required under pertinent sections of specifications.
- D. Prepare and include additional data when the need for such data becomes apparent during instruction of Owner's personnel.
 - E. Additional requirements for operating and maintenance data: The respective sections of specifications.

1.06 SUBMITTAL SCHEDULE

- A. Submit 2 copies of preliminary draft of proposed formats and outlines of contents for each containerized system prior to delivery of the units to the docks in Seattle.
 1. Engineer will review draft and return 1 copy with comments.
- B. Submit specified number of copies of approved data in final form prior to the scheduled date for receiving payment for 75% of the work.

END OF SECTION

1. GENERAL

A. LIST OF ARTICLE TITLES

- 1.01 DESCRIPTION OF WORK
- 1.02 QUALITY ASSURANCE
- 1.03 SUBMITTALS
- 1.04 GUARANTEE

- 2.01 GENERAL DESCRIPTION
- 2.02 DESIGN CRITERIA
- 2.03 HOT WATER BOILERS B-01, B-02
- 2.04 UNIT HEATER
- 2.05 CIRCULATING PUMPS
- 2.06 PROCESS WATER PUMPS
- 2.07 CHEMICAL POT FEEDER
- 2.08 HEAT EXCHANGER
- 2.09 EXPANSION TANK
- 2.10 THERMOMETERS
- 2.11 DAY TANK
- 2.12 CONTAINER
- 2.13 GATE VALVES
- 2.14 PIPE
- 2.15 TEMPERATURE CONTROL SYSTEM
- 2.16 CONTROL PANEL
- 2.17 FIRE ALARM
- 2.18 FIRE SUPPRESSION

- 3.01 INSTALLATION
- 3.02 CLEANING
- 3.03 TESTING

1.01 DESCRIPTION OF WORK

- A. The work covered in this section consists of furnishing all labor, materials, and equipment necessary to provide a fully operational and functional containerized process water heating system as a base bid or a skid mounted unit for SGH in Valdez, Alaska as Bid Alternate No. 1. The system shall be similar to that shown on the layout and flow Schematic Drawings. Overall layout, construction, acquisition of products however shall be finalized by the Contractor.

- B. The containerized process water heating system shall consist of two oil fire boilers, one process water to boiler system heat

exchanger, process water pump, glycol system pumps, expansion tank, chemical pot feeder, day tank, piping, temperature control valve with a set point controller, isolation valves, unit heater, lighting, convenience outlets, insulated and gypsum board lined used seaworthy container with outside air louvers, painting, controls and power entrance for a single 480 volt, 3 phase connection. The containerized system is to be fully functional ready for shipment to Whittier or Valdez, Alaska.

- C. Bid Alternate No. 1: In place of a containerized system for SGH in Valdez provide as Bid Alternate No. 1 a fully functional skid mounted heating system. The requirements for this system are the same as the containerized systems except the equipment would be skid mounted. In addition to the container, the container improvements such as louvers, lighting, unit heaters, insulation, fire protection, convenience outlets and man door will not be provided. The skid shall include forklift pockets for transporting and the outside plan dimensions shall not exceed 10 feet by 17 feet and the height shall not exceed 8 feet.

1.02 QUALITY ASSURANCE

- A. Contractor shall have fabrication capabilities for the construction of the containerized boiler system. Contractor shall have a minimum of 10 years of experience in the design and installation of hot water boiler systems.
- B. Service engineer: After delivery of the boiler system to the job site and installation by the site contractor, the fabrication contractor shall provide the services of the manufacturer's field representative for starting the units and training the operator for a minimum of 2 days excluding travel time for each containerized system.

1.03 SUBMITTALS

- A. Product data: All equipment.
- B. Shop drawings: In accordance with Section 01300. Include dimensioned layout drawings showing piping, electrical control requirements, boiler control schematics, temperature control value requirements, lighting, etc.
- C. Operation and maintenance manuals: Include parts lists and control schematics for each specific model of equipment. Furnish in accordance with Section 01730, Operating and Maintenance Data.

1.04 GUARANTEE

- A. Containerized boiler system shall be warranted for 1-year following acceptance of the system, Section 01700, Project Closeout.
- B. Contractor shall ensure containerized system for its replacement value to the point of delivery specified in Bid Form.

2. PRODUCTS

2.01 GENERAL DESCRIPTION

- A. For the base bid the Contractor shall obtain a used shipping container, insulate and surface the interior walls, ends and ceiling with 5/8-inch gypsum board. The container shall be modified to include wall louvers for boiler combustion air, boiler stacks (through the wall preferred at WNH, AFK, and CCH; ceiling at SGH), lighting, a 2-foot 6-inch steel man door on three of the containers, convenience outlets and an electric unit heater for freeze protection. The exterior of the container shall be painted, the interior of the container shall be painted on the floor, walls, ends, and ceiling. Wiring for lights, switches and outlets shall be concealed by the gypsum board liner, or in exposed conduit. Locks shall be included for all doors.
- B. As Bid Alternate No. 1, the Valdez Heating System (SGH) shall be delivered as a skid mounted unit. The skid shall be no larger than 10 feet by 17 feet and shall be designed to be placed into an existing building upon delivery to Valdez, Alaska. The system shall be "laid out" similar to the containerized system to match the building requirements. The skid shall be fabricated of steel, rigid enough to allow safe transportation of the heating system and include forklift pockets to allow for transport in Valdez. The skid shall be painted as specified for the containerized system. Except for the container, container improvements, unit heater, and fire suppression system, the skid mounted system shall be the same as the containerized systems.
- C. Inside of the container the Contractor shall develop a complete boiler/heat exchanger system to heat process water in the volume and temperature specified in Paragraph 2.02. The boiler system shall be fully automated such that the desired process water temperature can be set through a set point controller and automatically maintained with varying process water flow rates and incoming temperature.

- D. The control panels shall be fully designed and fabricated by the Contractor to include all necessary relays, motor starters, temperature relays, etc. to allow a single 480 volt, 3 phase power connection. Metering of this power will not be required.
- E. Utilities including fuel oil, supply and return process water connections, domestic water, and power will be supplied at each hatchery location. It is required that the connections be made inside the container to prevent damage to any potentially protruding element of the system. All boiler exhausts should be designed to leave the container through the side or ceiling to match the site requirements. All necessary penetrations through the container wall or ceiling for connection to on site piping shall be made by the Contractor and covered and sealed to be waterproof during shipping.
- F. An acceptable layout is provided for design suggestions. The Contractor may suggest an alternative layout as long as it complies with all applicable codes and allows for proper maintenance of equipment and retains the same man and piping access shown on the Drawings. The flow schematic is provided showing schematically the desired piping and control arrangement.
- G. Piping inside of the container shall be copper for the two propylene glycol heating loops, PVC for the process water loop with at least 2 feet of steel pipe where it attaches to the heat exchanger to prevent "heat drift" to the PVC system, copper or black steel for the fuel oil piping. In no instance may any yellow metal piping or equipment come into contact with the process water.
- H. The contents of the container shall be layed out so that the load is evenly distributed and the container can be handled by a forklift.

2.02 DESIGN CRITERIA

- A. The containerized two boiler system shall be designed to meet the following process water conditions:
 - 1. Minimum flow rate: 50 gpm.
 - 2. Maximum flow rate: 200 gpm.
 - 3. Minimum incoming temperature: 35 degrees F.
 - 4. Maximum incoming temperature: 49 degrees F.

5. Required ΔT in the heated side stream is 21 degrees F at maximum process water temperature and 200 gpm flow rate. Contractor shall account for all inefficiencies in heat transfer.
- B. The process is to use two boilers. The boilers shall be sized so that each boiler can supply 60 percent of the total heat required. The process shall use a single plate and frame heat exchanger sized to meet the above design criteria. The temperature controller and mixing valve must maintain the set water temperature to ± 0.5 degrees F.
 - C. The process water circulation pump shall be sized to allow for fluctuations in flows. The process water flows are expected to range between 50 and 200 gpm depending on which valves are open downstream of the heating system. The two glycol circulating pumps shall be sized by the Contractor to meet the heating and control requirements stated above using 50% propylene glycol.

2.03 HOT WATER BOILERS (B-01, B-02)

- A. Boilers shall be constructed of cast-iron sections manufactured in accordance with ASME requirements for low pressure boilers. The boiler-burner unit shall not require a refractory combustion chamber and the sections shall be of wet base construction and suitable for installation on combustible floors.
 1. Boiler sections shall be assembled with precision machined cast-iron push nipples, pressed into mating machined nipple port in the section eliminating the need for any material such as gaskets.
 2. Boiler shall have individual clean-out openings between sections covered with insulated cast-iron covers with rope gaskets to ensure a gas-tight seal.
 3. The boiler jacket shall be constructed of heavy gage steel with 1/2-inch insulation and have a rust resistant baked enamel finish. Boilers shall be rated for installation on combustible floor.
 4. Water boiler sections shall be hydrostatically tested for 50 psi water working pressure in accordance with ASME Code Section IV.
 5. Water boiler trim shall include a 3-1/2-inch pressure temperature gage with separate scales for pressure and water temperature. In addition, an ASME approved water

relief valve shall be factory furnished and sized to exceed the boiler output capacity and shall be factory set to relieve pressure at 50 psi.

6. Each boiler shall have automatic reset high limit, automatic reset low water cutoff.
-
- B. Burner shall be forced draft. Burner shall be complete with integral motor driven blower, fuel oil electric ignition assembly, combustion safeguard, motor starters, complete fuel train including pressure regulator and all valves and all necessary controls for safe and efficient operation in accordance with IRI requirements. Mode of operation shall be full modulation with proven low fire start. Boiler shall have a net hot water output of sufficient BTU to meet the heating water requirement identified in Paragraph 2.02 when including boiler and heat exchanger efficiencies and pipeline losses when fired on fuel oil.
 - C. The boilers shall operate in a lead-lag system integral with the burner control panel(s) and shall allow for manual selection of the lead boiler. Lag boiler shall automatically fire when the lead boiler is unable to satisfy the system load. If the process water circulating pump is shut down (zero flow) the remainder of the boiler system shall remain on and the boiler system shall operate to maintain a fixed boiler temperature without damage.
 - D. Control cabinet shall be mounted on front of burner and shall include:
 1. Manual-automatic selector switch and manual firing rate potentiometer shall permit either automatic firing in accordance with load demands, or manual control of firing rate at any desired point between low fire and maximum rating.
 2. Burner package shall consist of:
 - a. A series of annunciation lights mounted to allow operators a view of the operational status.
 - b. A prewired and factory tested wiring harness and quick disconnect device that enables quick removal of door from cabinet.
 - c. Functions to be displayed for full modulation:
 - 1) Power on

- 2) Limit circuit closed
 - 3) Modulation mode
 - 4) Flame failure
- E. All control circuits shall be 120 volts, 60 Hz, 1 phase, with all switches in the underground leg. Fuse protection for the control circuit shall be provided. Electrical supply to the boiler(s) will be 120 volt single phase.
- F. Boiler stack may either be Metalbestos double wall self insulating or insulated welded steel. Stack shall be stainless and sized to meet the backpressure requirements of the boiler. Boiler stack shall be directed out through the side of the container for 3 units and through the roof on one. For the SGH unit for Valdez the container shall supply enough boiler stack to extend a minimum of 12 feet above the container and 13 feet of breeching for a total of 24 feet of stack outside of the container.
- G. Accessories: Provide all necessary accessories to make the system a fully operational and functional system meeting all applicable boiler and building codes and Fire Marshal requirements.
- H. Boiler shall be installed on a drip pan to contain any oil spill at the boiler.

2.04 UNIT HEATER

- A. Unit heater shall be Trane, 5 kW, or equal single stage, 480 volt, 3 phase units with heavy gage steel casing with baked enamel finish, factory horizontal wall/ceiling mounting bracket, adjustable louvers, finned tubular steel elements, totally enclosed motor, manual reset thermal overload protection for motor and elements, integral factory installed thermostat and disconnect. Units shall be UL rated and conform to all applicable local and national codes. Integral thermostat shall activate unit on a drop in temperature to 45 degrees F, and shut off unit at 55 degrees F.

2.05 CIRCULATION PUMPS (CP-01, CP-02)

- A. Close coupled glycol circulating pumps shall have capacities required to meet the heating load and headloss requirements of the piping, boiler heat exchanger, isolation valves and temperature control valve system. Close coupled pumps shall be of compact style, single stage, vertical split case design of bronze fitted construction. The pump internals shall be

capable of being serviced without disturbing the piping connections. The working pressure shall be 175 psi and the pump so nameplated.

1. The impeller shall be of the enclosed type, dynamically and hydraulically balanced and keyed to the shaft and secured with a suitable locknut.
 2. The pumps shall utilize a mechanical seal with a carbon seal ring and ceramic (or equal) seat.
 3. The bearing frame assembly shall be furnished with oil-lubricated sleeve bearings with readily accessible lubrication fittings.
 4. The pump shall be coupled to the motor by means of a spring type coupling to ensure quiet operation.
 5. The motors shall have sleeve bearings for 1,750 rpm selections and sleeve/ball bearings for 3,500 rpm selections.
 6. The pump shall be factory tested at the operating conditions specified, thoroughly cleaned, and painted with one coat of machinery enamel. A set of installation-and-operation instructions shall be packed with each pump.
 7. The motor shall be resilient mounted, equipped with oil lubricated journal bearings.
 8. The pump shall be factory tested, thoroughly cleaned, and painted with one coat of machinery enamel prior to shipment. A set of installation instructions shall be included with the pump at the time of shipment.
- B. Operating voltages and controls integral horsepower drive motors shall be 460 volt, 3-phase, 60 hertz. Provide combination starter and start/stop controls. Fractional horsepower motors shall be 120 volt, single phase.

2.06 PROCESS WATER PUMP (P-01)

- A. Process water pump shall be similar to the circulating pumps except as stated below. The capacity to pump 50 to 200 gpm with a residual pressure following the heat exchanger HX-01 of 30 psi. The full head of the pump is to be determined by the Contractor following his pipe routing, boiler and heat exchanger selection. Close coupled pumps shall be of compact style, single stage, vertical split case design of all iron

construction. The pump internals shall be capable of being serviced without disturbing the piping connections. The working pressure shall be 175 psi and the pump so nameplated. The pump shall contain no yellow metals that can come into contact with the process flow.

2.07 CHEMICAL POT FEEDER

- A. Feeder capacity shall be at least 1/1000 times the system volume. A label shall be affixed to the feeder stating the approximate system volume in gallons.

2.08 HEAT EXCHANGERS (HX-01)

- A. Heat exchanger shall be of the plate and frame type for use with heating water. The exchanger shall be of the counterflow type and contain no yellow metals. Frames shall be of carbon steel with baked epoxy enamel finish and chrome plated carbon-steel guide bars, zinc-plated carbon-steel tie bolts, and zinc-treated painted protection shroud. Plates shall be of 304 stainless steel with gaskets of NBR. Gasket and plate design shall be such that there is no possibility of cross contamination of flows. Nozzles shall be 150-pound ASA rated hose flange type. Head loss shall be included in process water pump (P-01) requirements. Heat exchanger shall be sized to be used with 50% propylene glycol.

2.09 EXPANSION TANKS

- A. Expansion tanks shall be Bell and Gossett, or equal. Tanks shall be sized by the Contractor.

2.10 THERMOMETERS

- A. Thermometers for determining water temperatures shall be industrial grade, adjustable angle constructed of die cast aluminum with a vee shape. The case shall have a chrome plated finish. Scale ranges shall be selected to provide "normal" readings at approximately midscale for the particular use. The bulb chamber shall be machined to match the tapered separable socket to assure metal to metal contact. Thermometer shall be adjustable for a full 180 degree rotation. Thermometers shall have a 9 inch scale.
- B. Thermometers shall be provided at the following locations and where shown on the drawings:
 - 1. Heating water inlets and outlets of both boilers.

2. Inlets and outlets of heat exchanger (all four ports of all HX's).

2.11 DAY TANK

- A. A 10 gallon day tank shall be provided to supply fuel oil to the boilers. The fuel system supplying fuel to the day tank is single pressurized line and the day tank must be able to "shut-off" the flow when full with either a normally closed solenoid valve or float valve. Provide a "catch tray" under the day tank to capture any overflows. The day tank shall include an audible high level alarm in case the tank fill valve sticks open. Day tank shall be Simplex, or equal.

2.12 CONTAINER

- A. For the base bid the Contractor shall obtain a good used steel seaworthy watertight container to house each packaged heating system. The container shall have forklift pockets and be in structurally sound condition. The container shall be cleaned and include 5/8-inch thick Type X gypsum board on the walls, ends, and ceiling attached with galvanized screws to 2-inch by 2-inch studs which are glued to the wall and ceiling and secured with gasketed galvanized screws from the outside of the container or equivalent to maintain a watertight container. The container shall be insulated with 1-1/2 inches of extruded polystyrene insulation. The floor shall be prepared and painted with 2 coats of floor paint following the manufacturer's requirements for preparatives and application. The exterior shall be prepared and painted with 2 coats of high gloss enamel paint applied per the paint manufacturer requirements.
- B. The container shall have a minimum of three 2 tube 4-foot long fluorescent lights operated by a light switch located adjacent to the doors. The container shall include 4-duplex convenience outlets for power tools. Wiring for the lights shall be concealed beneath the gypsum board or in surface mounted conduit.
- C. The container and all exposed components on the container shall be designed for a minimum of 125 psf snow load.
- D. A man-door shall be installed on 3 of the 4 containers as identified on the Drawings.

2.13 SKID

- A. For Bid Alternate No. 1 the skid shall be made of fabricated steel and include forklift pockets. The skid shall be rigid

enough to allow transport without damaging the equipment or interconnecting piping or electrical conduits. The maximum outside dimensions of the skid shall be no larger than 10 foot by 17 foot to fit into an existing building.

- B. The skid shall be painted with a rust prohibitive primer and finished with 2 coats of floor paint.

2.14 GATE VALVES

- A. Gate valves for the glycol circulating system shall be iron body, bronze-mounted, double disc, nonrising stem, 200-pound working pressure, threaded or flanged. Flange ends shall be Class 125 in accordance with ANSI B16.1.
- B. Gate valves for the process water shall be similar to above except they shall contain no yellow metals.
- C. PVC valves for the process water shall be butterfly valves or ball valves. Butterfly valves shall be ASAHI or equal. Ball valves shall be ASAHI, or equal.

2.15 PIPE

- A. PVC pipe shall conform to ASTM D 1785 and shall be Schedule 80 with solvent weld joints or flanged. Connections to all valves shall be flanged.
- B. Copper pipe shall be Type K or L with soldered fittings. Solder shall contain no lead.

2.16 TEMPERATURE CONTROL SYSTEM

- A. The temperature control valve shall be a Tekmar 4-way mixing valve with electric operator, or equal.
- B. Motor for temperature control valve shall be sized for continuous service.
- C. The set point controller shall be Tekmar Type 153 or equal. The unit shall have a control accuracy of ± 0.5 degrees F and shall include a digital display for setpoint and measured temperature. The controller shall modulate the 4-way valve to control the flow of hot water to maintain the setpoint temperature of the process water.
- D. The temperature sensor shall be installed in a stainless steel thermo-well. A strap on sensor will not be acceptable.

outside dimensions of the skid shall be no larger than 10 foot by 17 foot to fit into an existing building.

- B. The skid shall be painted with a rust prohibitive primer and finished with 2 coats of floor paint.

2.14 GATE VALVES

- A. Gate valves for the glycol circulating system shall be iron body, bronze-mounted, double disc, nonrising stem, 200-pound working pressure, threaded or flanged. Flange ends shall be Class 125 in accordance with ANSI B16.1.
- B. Gate valves for the process water shall be similar to above except they shall contain no yellow metals.
- C. PVC valves for the process water shall be butterfly valves or ball valves. Butterfly valves shall be ASAHI or equal. Ball valves shall be ASAHI, or equal.

2.15 PIPE

- A. PVC pipe shall conform to ASTM D 1785 and shall be Schedule 80 with solvent weld joints or flanged. Connections to all valves shall be flanged.
- B. Copper pipe shall be Type K or L with soldered fittings. Solder shall contain no lead.

2.16 TEMPERATURE CONTROL SYSTEM

- A. The temperature control valve shall be a Tekmar 4-way mixing valve with electric operator, or equal.
- B. Motor for temperature control valve shall be sized for continuous service.
- C. The set point controller shall be Tekmar Type 153 or equal. The unit shall have a control accuracy of ± 0.5 degrees F and shall include a digital display for setpoint and measured temperature. The controller shall modulate the 4-way valve to control the flow of hot water to maintain the setpoint temperature of the process water.
- D. The temperature sensor shall be installed in a stainless steel thermo-well. A strap on sensor will not be acceptable.

2.17 CONTROL PANEL

- A. The control panel shall be complete with all required motor starters, relays, transformers, pushbuttons, running lights, hour meters, etc. to provide a complete operating boiler and temperature control system in the heated and lighted shipping container. The panel enclosure shall be NEMA 1 and have all necessary start/stop and monitoring features on the front panel. To operate the water heating system it should not be necessary to open the control panel.
- B. The controls shall be set up to manually start each system and then automatically maintain the setpoint temperature of the process water. The control panel shall be designed so that any failure will not overheat the water causing harm to the fish. The control panel shall include an audible alarm to indicate a drop in temperature (adjustable) below setpoint.
- C. The control panel shall be designed so that a single 480 volt, 3 phase connection can be made at the hatchery and all systems are operational including the 120 volt and lower voltage systems.
- D. All alarms shall be audible outside of the container, and provided a spare set of normally open and normally closed contacts for future connection to the existing alarm system at each hatchery.

2.18 FIRE ALARM

- A. A fire alarm sensor shall be provided inside of the container. The alarm shall provide an audible alarm outside of the container, and provided a spare set of normally open and normally closed contacts for future connection to the existing alarm system at each hatchery.

2.19 FIRE SUPPRESSION

- A. Container shall include a packaged automatic dry chemical fire suppression system suitable for use in closed containers specified. The system shall include a high temperature switch and smoke detector and the system shall be activated by either activation of the system shall sound an external alarm and include a normally open and normally closed contacts for future connection.

3. EXECUTION

3.01 INSTALLATION

- A. All drains shall be piped to outside of the container.
- B. Boiler: The boilers shall be installed in strict accordance with the manufacturer's instructions in the mechanical rooms so that the service requirements are met. Start-up shall be supervised by manufacturer's qualified and authorized representative. Manufacturer's representative shall provide demonstration and instruction to owner's operating personnel. All boilers shall be installed on a noncombustible pad with a drip pan.
- C. Specialties:
 - 1. Balancing and temperature control valves shall be installed and provided so that 1) they may be adjusted, 2) so that the measuring lines may be attached, and 3) so that the insulation covers may be installed and taped in place.
 - 2. Exhaust stacks shall be coordinated with the equipment supplied assuring that pressure developed in the stack is acceptable for piece of equipment.
 - 3. Stacks shall be completed during fabrication of the unit, removed for shipping, the stack penetration made waterproof, and reinstalled for final installation.
- D. Note the drawings show design configurations based on particular manufacturer's equipment. If selected manufacturer's equipment configuration is different from that which is shown, the Contractor shall provide all necessary modifications to support the boiler system, fuel supply, electrical requirements, and piping systems at no additional cost to the owner.
- E. Piping: Piping shall be run in straight horizontal and vertical runs. Pipes shall be supported from the floor wherever possible. Pipes and equipment shall be supported to allow transport of the container without damaging the piping or equipment. All low spots in the piping shall include a drain valve and high spots an air release valve. Connections to equipment shall include isolation valves so the equipment can be removed for service without draining the entire system. The system shall include a bypass line so that a single boiler can be removed from service without impacting the second boiler.

Valves shall be installed for isolation at each hatchery connection point.

- F. All water piping and valves shall be insulated with a minimum of 2 inches of fiberglass preformed insulation with an exterior vapor barrier.

3.02 CLEANING

- A. Prior to shipping the Contractor shall fill the hot water piping system with a solution of water and tri-sodium phosphate mixed at a concentration of 1 pound tri-sodium phosphate per 50 gallons of water. Vent system to assure complete fill and circulate the cleaning solution for a 3-hour duration. Flush system completely as many times as necessary to obtain a flushed water pH reading of 7.0. Remove startup strainer element after flushing entire system and prepare for shipment to Alaska.

3.03 TESTING

- A. After the Owner has installed the unit the Contractor shall fill the system with 50% propylene glycol solution and perform functional tests and start-up of all equipment specified herein for a minimum period of 2 days for each containerized system with various thermostat settings to assure proper operation over the full design range. It is anticipated that this will occur during July or August 1995.
- B. All equipment shall be tested for proper operation, bearing integrity and performance by the Contractor once the installation is complete.
- C. The testing and start-up of all equipment specified herein shall be done by authorized manufacturer's representative or direct employee. Written reports of this testing and start-up shall be supplied to the Owner.
- D. Specialties shall be tested as part of the circulating system except that air vents shall not be installed until system has been thoroughly flushed and dirt removed.

- E. The Contractor shall furnish all equipment, material and labor to perform the testing at the installation site including travel costs to and from Cordova and Valdez. PWSAC will provide transportation between Cordova and each remote site, and all living accommodations at the sites and in Cordova, AK. Valdez Fisheries Development Association will provide transportation and living accommodations in the City of Valdez and at Solomon Gulch Hatchery.

END OF SECTION