

ANNUAL PROGRAM STATUS SUMMARY

- a) **Program Number:** 12120114
- b) **Program Title:** Long-term Monitoring of Marine Conditions and Injured Resources and Services
- c) **Team Lead(s) Submitting the Report:** Molly McCammon, Kris Holderied, Katrina Hoffman
- d) **Time period covered:** 1 February 2012 to 31 January 2013
- e) **Date of Report:** 1 March 2013
- f) **Program website (if applicable):** <http://www.aoot.org/gulfwatchalaska>

g) Program status:

In the two decades since the Exxon Valdez oil spill, it has been recognized that full recovery from the spill will take decades and requires long-term monitoring of both the injured resources and other factors to determine what may inhibit the system from recovering to pre-spill conditions. This requires an integrated monitoring program that provides information about environmental drivers and the open water (pelagic) and nearshore benthic components of the marine ecosystem. The proposed work leverages existing data and monitoring programs to build information on the ecosystem beyond the five-year duration of this proposal. The overarching goal of the long-term monitoring (LTM) program is to provide sound scientific data and products that inform management agencies and the public of changes in the environment and the impacts of these changes on Exxon Valdez oil spill (EVOS) injured resources and services. To accomplish this goal we are conducting a five-year ecosystem monitoring program in the spill-affected region, which is anticipated to be the beginning of a twenty year effort. To improve outreach and in consultation with EVOS Trustee Council (EVOSTC), a new name was established for the program - *Gulf Watch Alaska, The Long-term Monitoring program of the Exxon Valdez Oil Spill Trustee Council*.

The long-term monitoring program (now Gulf Watch Alaska) has six main objectives:

- Sustain and build upon existing time series in Prince William Sound, lower Cook Inlet and adjacent Gulf of Alaska coast.
- Provide scientific data, data products and outreach to management agencies and a wide variety of users.
- Develop improved monitoring for certain species and ecosystems.
- Develop science synthesis products to assist management actions, inform the public and guide the evolution of monitoring priorities for the next 20 years.
- Enhance connections between and integration of monitoring projects and between the LTM and Herring Research and Monitoring (HRM) program.
- Leverage partnerships with outside agencies and groups to integrate data from a broader monitoring effort than that funded by the Trustee Council.

The Gulf Watch Alaska program management team includes Molly McCammon with the Alaska Ocean Observing System (AOOS) as the overall team lead, Katrina Hoffman with the Prince William Sound Science Center (PWSSC) as the administrative lead, and Kris Holderied with the NOAA Kasitsna Bay Laboratory (KBL) as the science lead. Gulf Watch Alaska is composed of integrated program management, data services, science synthesis, and outreach efforts, as well as 14 ecosystem monitoring projects. The monitoring projects are further organized as 1) environmental drivers, 2) benthic nearshore (including lingering oil) and 3) pelagic components. All projects in the program are listed below, as well as the organizations involved for each one. Most of the monitoring projects are conducting fieldwork every year.

Gulf Watch Alaska team:

A. Integrated program management, data services, outreach and science synthesis

1. Program coordination and logistics – Prince William Sound Science Center (PWSSC) and Alaska Ocean Observing System (AOOS)
2. Outreach - AOOS
3. Data management –AOOS/Axiom Consulting
4. Historical data management and synthesis – National Center for Ecological Assessment and Synthesis (NCEAS) – EVOS TC Project# 12120120
5. Science coordination and synthesis – NOAA Kasitsna Bay Laboratory (KBL)
6. Conceptual ecological modeling– Alaska Sea Life Center (ASLC)

B. Environmental drivers monitoring component

7. Gulf of Alaska mooring (GAK1) monitoring – University of Alaska Fairbanks (UAF)
8. Seward Line oceanography and plankton monitoring – UAF
9. Oceanographic conditions in Prince William Sound – PWSSC
10. Oceanographic monitoring in Cook Inlet – Alaska Department of Fish and Game (ADFG) / Kachemak Bay Research Reserve (KBRR) and NOAA Kasitsna Bay Laboratory (KBL)
11. Continuous plankton recorder –Sir Alister Hardy Foundation for Ocean Science (SAHFOS)

C. Pelagic monitoring component

12. Ability to detect trends in nearshore marine birds – US National Park Service (USPS) Southwest Alaska inventory and monitoring Network (SWAN) – year 1 funding only
13. Long-term killer whale monitoring – North Gulf Oceanic Society (NGOS)
14. Humpback whale predation on herring – NOAA National Marine Fisheries Service (NMFS) Auke Bay Laboratory & University of Alaska Southeast (UAS)
15. Forage fish distribution and abundance – U. S. Geological Survey (USGS) Alaska Science Center
16. Prince William Sound marine bird surveys – U.S. Fish and Wildlife Service (USFWS)

D. Benthic monitoring component (including lingering oil projects)

17. Nearshore benthic systems in the Gulf of Alaska – USGS Alaska Science Center/ USNPS SWAN, Coastal Resources Associates
18. Monitoring ecological communities in Kachemak Bay – UAF
19. EVOS oil exposure of harlequin ducks and sea otters – USGS Alaska Science Center
20. Oil level and weathering tracking in PWS over time– NOAA/NMFS Auke Bay Laboratory

In the first year of the Gulf Watch Alaska program, much of the effort has been focused on getting the individual projects underway and expanding coordination among investigators as well as with other research efforts in the region. The budget year for the overall program, as determined by the Exxon Valdez Oil Spill Trustee Council (EVOSTC), runs from February 1 to January 31 each year. Most investigator agencies and organizations have fiscal years that run from October 1 to September 30 or July 1 to June 30. The Program Management Team, EVOSTC staff and principal investigators have worked to accommodate differences between agency and program fiscal years and align budget execution with the EVOSTC program schedule.

Jeep Rice, the lead for the pelagic component and Jim Bodkin, a PI in the benthic component, both retired recently after many years of federal service with NOAA and USGS, respectively. The entire team deeply appreciates their long service to the nation, our Alaska communities, and to conservation of healthy Alaska marine resources.

h) Summary of Work Performed: (Note: See Appendix 1 for individual project reports)

1. Integrated program management, data services, science synthesis & outreach (leads – McCammon, Holderied and Hoffman)

Program coordination and logistics – Hoffman (PWSSC)

The initial focus of program coordination effort was to establish the funding contracts for the non-trustee agency principal investigators (PIs) and re-format the proposal to meet NOAA submission requirements. Contract management has proceeded as expected. The Program Management Team has met regularly and coordinated with investigators, Trustee Council staff and NOAA contract officers to establish the reporting requirements and develop a Program Management Plan for the LTM program. The LTM Program Management Plan was finalized in May 2012, with concurrence from all program PIs. A PI meeting was conducted in Anchorage in November 2011, followed by a shorter PI meeting at the January 2012 Alaska Marine Science Symposium in anticipation of the program launch. Most PIs attended both meetings in person. Quarterly PI teleconference meetings were held in May and October 2012. An annual in-person PI meeting was held in November 2012 in Anchorage, in conjunction with a Herring Research and Monitoring program PI meeting the same week. Program managers and numerous PIs attended the Alaska Marine Science Symposium in January 2013 with PIs making six oral or poster presentations directly related to results from the Gulf Watch Alaska program. The Gulf Watch Alaska team also co-hosted a public evening session at the 2013 Symposium on Gulf of Alaska research with the Herring Research and Monitoring program and the NPRB Gulf of Alaska Integrated Ecosystem Research Program. Meeting organization and travel reimbursement has been completed for PI meetings.

Outreach and Community Involvement – McCammon (AOOS)

The Outreach and Community Involvement Steering Committee was formed this past year and has met seven times. The Committee includes key outreach staff from AOOS, PWSSC, Kachemak Bay Research Reserve, Alaska Sea Life Center, North Pacific Research Board, COSEE Alaska, and NOAA. A basic suite of outreach materials has been developed for the program. Completed thus far are a new name (Gulf Watch Alaska, The Long-term Monitoring program of the Exxon Valdez Oil Spill Trustee Council), logo, PowerPoint and poster templates, pop-up displays, brochure, presentation folder and bookmarks. AOOS staff developed a project website (www.aos.org/gulfwatchalaska). AOOS staff and the project management team also prepared materials for a 2-page insert included in the summer 2012 Delta Sound Connections science newspaper that is printed and circulated by PWSSC throughout south-central Alaska.

Hoffman gave a Gulf Watch Alaska presentation to 221 members of the general public at Ocean Fest in Cordova, Alaska on September 15, 2012. Holderied gave Gulf Watch Alaska presentations at the Alaska Marine Science Symposiums in January 2012 and January 2013, the Kachemak Bay Science Conference in March 2012, the National Park Service Alaska Science Symposium in October 2012, and to the Kachemak Bay Research Reserve Community Council in December 2012.

Data Management – McCammon/Bochenek (AOOS/Axiom)

Initial efforts of the Data Management project focused on establishing protocols for data transfer and metadata requirements, as well as implementing the AOOS Ocean Workspace as a cross-program information sharing and organization tool. The Workspace has been rolled out to PIs and individual user and group profiles created. Axiom has hosted several training seminars via webinars and PIs are beginning to use the system to organize and consolidate their project level data. The data salvage effort has begun with prioritization from lead investigators, NCEAS Staff and engagement of the Alaska Department of Fish & Game office in Cordova, AK. Software engineers at Axiom have also

been working to support the Workspace, resolving technical bugs and implementing new functionality in response to user feedback.

Collaborative data management and holistic synthesis of impacts and recovery status associated with the Exxon Valdez Oil Spill – Jones (NCEAS)

The team has identified 463 clusters of research projects funded by the EVOSTC that collected historical data, enumerated and prioritized the projects for data salvage, and have contacted 84 out of 222 PIs for those projects. This effort has produced data for 61 data sets, of which 11 have been fully organized, documented, and published on both the Gulf Watch Member Node site and the AOOS Ocean Workspace. They have created a prototype Gulf Watch data repository that houses historical data as they are published and that can replicate data as part of the DataONE network of repositories. Software tools for data management have been extended to interoperate with the Gulf Watch Repository, including the Morpho data documentation tool and the Kepler Scientific workflow system. Due to initial delays in establishing the initial contract the project schedule has been compressed and some unspent year 1 funds will facilitate completion of the work in year 2. The originally projected year 2 budget does not change and no major delay in accomplishment of milestones is anticipated.

Science Coordination and Synthesis – Holderied (NOAA KBL)

Science coordination was the primary focus of this project during the first Gulf Watch Alaska ecosystem monitoring program year, as expected, with an increase in science synthesis-related efforts starting with the November 2012 annual PI meeting. In addition to the PI meetings (outlined above), the program's Science Coordinating Committee has also met routinely via teleconference, in addition to the PI meetings, in order to plan PI meetings, develop the Program Management Plan, provide input on needed data management services, develop the year 2 work plan, discuss plans for the Science Technical Oversight Committee and address on-going program coordination issues. To ensure consistency in the monitoring program over time, all PIs are preparing written sampling protocols for their monitoring projects and submitting them to the program management team. All protocols will be made available to the program PIs via the Ocean Workspace website. The sampling protocols will supplement the required metadata submitted with monitoring data. With support from the data management team, information on current field survey plans can be shared and routinely updated through an interactive Google document.

We are developing a variety of tools to communicate the scope and results of the monitoring effort between program investigators and to a broader audience of resource managers, other researchers and the general public. Figure 1 provides an example of a table developed to more easily visualize the 2012 field sampling efforts, across different disciplines. A primary focus of the November 2012 annual PI meeting was on how to improve the use of individual project data and cross-disciplinary information products by resource managers. In addition to project updates, all PIs reported on how their monitoring data is currently being used to support resource management and on additional ways in which it could be used in the future. In order to improve cross-program integration and support development of conceptual ecosystem models for the Gulf Watch Alaska program, the annual PI meeting included overviews of conceptual ecosystem modeling and decision support tools. Breakout sessions were conducted to start to refine a conceptual ecosystem framework for the Gulf of Alaska ecosystem, building on past efforts. PIs also tested a process that defines linkages between ecosystem components and then ranks the level of understanding that experts have of the different linkages. Preliminary efforts have been started to compile data visualizations from across the Gulf Watch Alaska program and to develop improved data visualizations for a variety of stakeholders, with an emphasis on meeting the needs of resource managers and providing useful information to local communities. See the individual Science Synthesis project description in the appendix for more details.

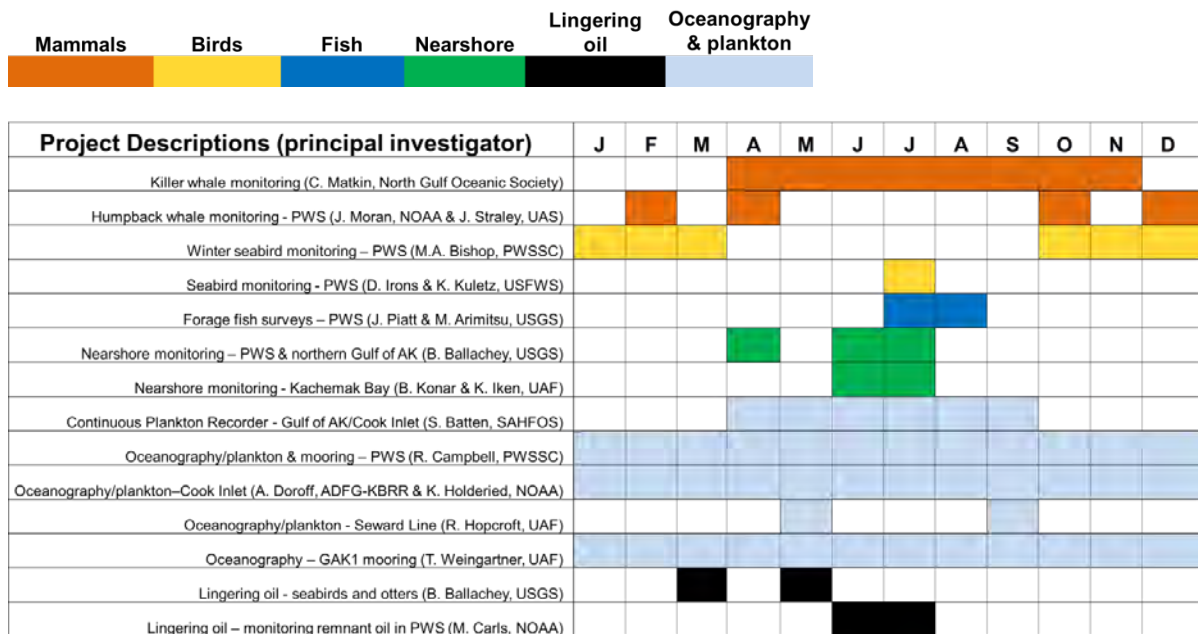

Figure 1. 2012 field sampling program and associated principal investigators. Legend at top indicates the type of sampling associated with each color.

Conceptual ecological modeling—Hollmen (ASLC)

A one-day modeling session was included in the agenda of the annual principal investigator meeting held in November 2012. The modeling session began with a series of introductory presentations focusing on ecosystem modeling tools, conceptual ecological models, and decision support tools for resource management. Input from this session is being analyzed and will be used to develop the draft conceptual ecosystem model as outlined in the study plan. A novel linkage rating tool was developed and tested by the principal investigators. Feedback received about the tool will be used to further develop linkage assessment tools for conceptual ecosystem modeling, and feedback on linkages will be incorporated into our ecological models.

Highlights from the monitoring projects are summarized below. Please see the individual project summaries in Appendix 1 for more detailed project status information.

2. Environmental Drivers Monitoring Component (leads – Weingartner & Hopcroft)

Long-term monitoring of oceanographic conditions in the Alaska Coastal Current from Hydrographic Station GAK 1—Weingartner (UAF)

The spring of 2012 was unusually cold, with temperature anomalies being 1C to 1.5C below normal between the surface and about 150 m depth. The most recent evidence of such deep cooling occurred in the winter of 2007. This work has identified the dominant winter atmospheric patterns over the Gulf of Alaska that lead to deep cooling on the Gulf of Alaska shelf (and adjacent waters). This deep cooling is usually associated with low winter coastal freshwater discharge, indeed a decrease in winter discharge enhances deep cooling. The decrease in winter discharge appears to delay the onset of stratification in spring, which may result in a delay in the onset of the spring phytoplankton bloom. Understanding the broad-scale atmospheric patterns that affect temperature and salinity distributions allows us a degree of predictability on ocean conditions in the northern Gulf of Alaska. We have also

identified some of the major causes for regional variability in air-sea cooling processes over the Gulf of Alaska shelf, including Southeast Alaska, within Prince William Sound, and around Kodiak Island and Lower Cook Inlet. This information provides teams within the Environmental Drivers and Herring Restoration components, as well as resource managers, a better understanding of local phenomena that may affect the ecosystems in which they work and why biological responses may be dissimilar around the Gulf of Alaska.

The Seward Line: Marine ecosystem monitoring in the Northern Gulf of Alaska—Hopcroft (UAF)
The September 11-19 cruise was challenged by weather, but all sampling was completed both along the Seward Line and in Prince William Sound. Oceanographically, the Seward Line was at or slightly below the long-term mean temperature during the May 2012 cruise. Temperatures during September were also unremarkable. Macronutrient and chlorophyll concentrations measured during May suggest the spring bloom was in progress along the Line during the cruise. The keystone zooplankton genus *Neocalanus* was slightly delayed in its life cycle, but near the long-term mean in terms of its abundance. There were no notable anomalies during the spring for other species.

Oceanographic conditions in Prince William Sound – Campbell (PWSSC)
Comparison of recent observations to a 30 year time series of temperature and salinity in central PWS shows a warming trend at all depths, a shift towards earlier surface warming in summer, and a freshening trend at the surface. A state-of-the-art profiling mooring is staged and will be deployed in early 2013. It will make observations of temperature, salinity, chlorophyll fluorescence, turbidity and nitrate concentration at much higher frequency (approximately daily) than has ever been done in the area. The delivery of the profiler was considerably behind schedule as the manufacturer had significant problems integrating the telemetry hardware for transmitting data from the profiler in real-time. However, it performed flawlessly in its first field test. Deployment of the profiler will occur in spring 2013 to take advantage of weather likely to permit regular servicing visits if needed after initial deployment. The Agilent 7100 Capillary Electrophoresis instrument (for nutrient analysis) was also purchased in 2012 and underwent preliminary testing and protocol development from August to December 2012. There were several significant setbacks, including a serious hardware failure (repaired under warranty). The capillary electrophoresis system is currently operational, and method development is ongoing into the first quarter of 2013.

Oceanographic monitoring in Cook Inlet & Kachemak Bay– Doroff (KBRR) and Holderied (NOAA/KBL)

- Through a partnership with the U.S. Fish and Wildlife Service, we are enhancing the Gulf Watch Alaska program to obtain seabird and marine mammal data that will improve understanding of relationships between these species, marine conditions and primary productivity.
- Oceanographic data (temperature and salinity) from this project is being used to validate an ocean circulation model being developed by NOAA's National Ocean Service for Cook Inlet. The model is being used by NOS to produce a tidal energy assessment of Cook Inlet, in partnership with the Alaska Energy Authority.
- The phytoplankton species that causes paralytic shellfish poisoning, *Alexandrium fundyense*, were found at all Kachemak Bay sampling locations throughout the summer, although at relatively low concentrations. *A. fundyense* concentrations were found to be significantly correlated with both water temperature and salinity conditions.
- The project leveraged partnerships with AOS and UAF to collect water samples for carbonate chemistry analysis. The data will be used to quantify how ocean acidification varies in estuary waters, potentially with phytoplankton blooms, melting glaciers, and upwelling of ocean waters.

Continuous plankton recorder – Batten (SAHFOS)

There is considerable interannual variability in the lower trophic levels on the Alaskan shelf with the latter half generally having lower abundances than the first half of the 13 year timeseries. There is a significant positive relationship between annual anomalies of diatom abundance and zooplankton biomass. 2011 saw the lowest recorded diatom abundance and zooplankton biomass in the time series which returned to near average in 2012. Other studies (e.g. NPRB's GOA IERP program) also saw low productivity in 2011 sampling, so that this was a widespread feature. It is likely that prey conditions for higher trophic levels were not favorable.

3. Pelagic Monitoring Component (lead – Rice, retired. New lead to be determined)

Ability to detect trends in nearshore marine birds – Coletti (USNPS/SWAN)

Skiff-based surveys, primarily for over-wintering sea ducks, were conducted along the coast of the Katmai National Park and Preserve (KATM) during March of 2012. We are planning on conducting similar surveys in March of 2013 along the coast of Kenai Fjords National Park (KEFJ). Marine bird and mammal surveys were completed in both KATM and KEFJ during the summer of 2012. These data will be incorporated into the proposed occupancy analysis.

Long-term monitoring of seabird abundance and habitat associations during late fall and winter in Prince William Sound—Bishop (PWSSC)

Six winter seabird surveys in Prince William Sound found pronounced differences in patterns of species occurrence. *Brachyramphus* murrelets, for instance, increased from October to December and had dispersed again by February. Increased frequency of winter sampling in Prince William Sound will allow for better understanding of differential timing of potential herring consumption by bird species during the winter in PWS.

Long-term killer whale monitoring in Prince William Sound/ Kenai Fjords—Matkin (NGOS)

2012 was a very successful year for photo monitoring of key pods and individual killer whales in Prince William Sound/Kenai Fjords. The remaining AB pod matriline has not increased since 2010 and contains 20 individuals, still not recovered from the 28 whales they contained the year prior to the spill. The AT1 transient population (Chugach transients) remains at 7 individuals (22 prior to spill) and they appear headed toward extinction. Time/depth tags indicated residents making foraging dives at much greater depths than expected: up to 500m. Future work will try to determine prey species, although work to date indicates salmon as primary prey.

Humpback whale predation on herring – Moran (NMFS/Auke Bay Lab) & Straley (UAS)

- During our first whale survey conducted during herring spawning (April 2012) we made three noteworthy observations: (1) 29 humpback whales associated with spawning herring. (2) A gray whale feeding on herring spawn or herring at Hell's Hole. A single gray had been reported in previous years and efforts will be made to determine if this is the same animal. Similar behavior from gray whales has been reported in Sitka Sound. (3) The observation of over 150 harbor porpoises off Knowles Head associated with spawning herring. This species was infrequently encountered as singles or in pairs in our previous 11 whale surveys in the PWS.
- During the October 2012 survey, we observed 8 whales feeding on dense schools of euphausiids. Anecdotal observations during this suggested a dramatic increase in forage fish and euphausiids relative to our other surveys.

Forage fish distribution and abundance – Piatt and Arimitsu (USGS/Alaska Science Center)

- Results from our midwater trawl survey suggest very high abundance of young of the year (YOY) walleye pollock throughout the Sound in 2012. Likewise, there was exceptionally high abundance of YOY pollock in ADF&G's PWS juvenile salmon surveys (Steve Moffitt, pers. comm.), and in Tufted Puffin diets in the central and eastern Aleutian Islands (Schoen et al. *in prep*). Together,

these observations suggest 2012 was a strong year class for walleye pollock in the Gulf Alaska and SE Bering Sea.

- In contrast to trawl catches in PWS during July 2010 (Arimitsu et al. *in prep*), when young of the year (YOY) capelin were abundant, we found no YOY capelin in July 2012. We collected ripe female capelin near glaciers in several fjords however, suggesting that timing of spawning for capelin appears to have been delayed in 2012 compared to 2010.
- This work will inform managers about changes in the prey base that may be responsible for predator population fluctuations. In addition to direct sampling of key forage species using state of the art instrumentation and net sampling methods, we are also collecting data on a variety of habitat variables that may influence the distribution and abundance of forage species over time. Taken as a whole, this research will help tease out the mechanisms for change in the ecosystem, whether that change is due to anthropogenic disturbance or natural variability.

Prince William Sound marine bird surveys – Kuletz and Irons (USFWS)

We successfully completed our planned marine bird survey of Prince William Sound (PWS) in July 2012. 2012 was a relatively cold and wet summer. Our field season was challenging, in part due to weather and to several major mechanical failures in our fleet of survey vessels, some of which have now been in service for 30 years. However, we were able to safely and successfully meet all of our data collection objectives within our schedule. This included over 2000 linear kilometers of marine bird surveys. One observation of interest this year was about 10 Kittlitz's murrelets in the general vicinity of Cordova. This is somewhat unusual because the majority of these birds are associated with tidewater glaciers in PWS. We also observed several groups of Sabine's Gulls, which are infrequently observed in PWS.

4. Benthic and Lingering Oil Monitoring Component (lead – Ballachey)

Nearshore benthic systems in the Gulf of Alaska – Ballachey (USGS Alaska Science Center)

- To understand linkages and structuring in the nearshore food web, we have initiated a study of stable isotopes in a broad suite of nearshore species. Initial results on macroalgae from study sites in western PWS show strong isotopic distinction among genera as well as considerable variation among sites. Results of analyses on invertebrates from the same sites are anticipated soon.
- The abundance of mussels from our three study areas (5 sites in each area, at Katmai, Kenai Fjords, and western PWS) have generally declined across areas over the past several years, although greater among-site variation was observed at Kenai Fjords. This decline may have implications for sea otters and black oystercatchers, both of which prey upon mussels; at Kenai Fjords and western PWS, a decrease in mussels as a proportion of the overall diet of sea otters has been noted over the corresponding time period. Sea otters at Kenai Fjords appear to have a greater dependence on mussels as a primary prey item than do otters in other areas, and thus fluctuations in the availability of mussels may have more impact on the well-being of sea otters there.

Long-term monitoring of ecological communities in Kachemak Bay: a comparison and control for Prince William Sound –Konar/ Iken (UAF)

Intertidal communities in Kachemak Bay were significantly different at sites along the south shore of the bay from sites at the north shore, especially at the lower intertidal strata. Mussel abundance was highly variable within and among sites in Kachemak Bay, but common to all three sites was the high frequency of small mussels (<5 mm) and low occurrence of large individuals (> 25 mm). Sea otters in Kachemak Bay had a mixed diet of crab, mussels, clams and sea urchins. Data produced in this monitoring can be used as baseline for managers to track future changes

EVOS oil exposure of harlequin ducks and sea otters – Ballachey (USGS Alaska Science Center)

- In 2011, harlequin ducks in western PWS showed evidence of continuing exposure to lingering oil based on measurement of the cytochrome P450 biomarker. Harlequins will be resampled in the same areas in March 2013 to evaluate whether or not exposure continues.
- An invited chapter has been submitted for publication: *The effects of spilled oil on coastal ecosystems: Lessons from the Exxon Valdez spill*, authored by J.L. Bodkin, D. Esler, S.D Rice, C.O. Matkin, and B.E. Ballachey, to be included in the forthcoming book Coastal Conservation, edited by Julie L. Lockwood and Brooke Maslo and published as part of the Cambridge University Press Series in Conservation Biology.

Oil level and weathering tracking in PWS over time– Carls (NMFS Auke Bay Lab)

- In general, hydrocarbon concentrations in Prince William Sound were low in 2012, ≤ 4 ng/g wet weight in mussel tissue (n=8) and ≤ 28 ng/g wet weight in sediment (n = 7; Payne et al)
- Some beaches remain heavily contaminated; hydrocarbon concentrations in bioremediation beaches (Boufadel et al) were high, 4.1×10^4 to 8.0×10^6 ng/g wet weight.
- Hydrocarbon composition in 2012 bioremediation samples was consistent with Exxon Valdez oil.
- New forensic modeling approaches with geochemical biomarkers provide definitive identification of stranded oil decades after stranding.
- Oil remains biologically available at some Gulf of Alaska locations (Irvine et al)

i) Summary of Future Work to be Performed:

We are on schedule with the original proposal, with the only significant change being the lag of some efforts from year 1 to year 2 due to delays in contract establishment, funding transfers or personnel hires. We do not anticipate any significant changes to program milestones. Due to the retirement of Jeep Rice from NOAA, we will have a new lead for the pelagic component and we will coordinate on that selection with EVOSTC staff.

j) Coordination/Collaboration:

During the program startup and first reporting year we had three in-person PI meetings in Anchorage that were attended by nearly all the investigators. The first meeting was in November 2011 and the second meeting was in November 2012, with the second meeting held the same week as the PI meeting of the EVOSTC funded Herring Research and Monitoring program. The third meeting was held in conjunction with the 2012 AMSS. Coordinating the PI meetings between the two programs provided investigators from both programs an additional opportunity to share information and expand collaborations.

Significant collaborations occurred between individual projects and with outside agencies. PIs with the Prince William Sound/Gulf of Alaska (Ballachey) and Kachemak Bay (Konar/Iken) benthic monitoring projects have closely coordinated on nearshore monitoring protocols. Plankton sampling protocols have been closely coordinated between the PWS (Campbell) and Cook Inlet (Doroff/Holderied) oceanographic monitoring projects and zooplankton analysis for the Cook Inlet project will be conducted by Campbell's group in order to ensure consistency between the two groups. Investigators from different projects have participated in each other's research cruises, beyond what was originally proposed, in order to increase consistency in sampling across the different sites and to leverage scientific capabilities across the integrated team. One example was a Cook Inlet PI (Doroff) joining the PWS nearshore benthic monitoring cruise to provide additional sea otter monitoring capabilities. The Cook Inlet oceanography monitoring project PIs are also collaborating with the U.S. Fish and Wildlife Service At-Sea Observer program to host a USFWS seabird observer on the seasonal lower Cook Inlet surveys, benefiting both the Gulf Watch and

USFWS programs. Expanded research collaborations have been an immediate benefit from having integrated ecosystem monitoring program.

k) Community Involvement/TEK and Resource Management Applications:

Initial community involvement efforts have been aimed at providing information on the program through public presentations at a variety of formal and informal venues and engaging community members in discussions on how Gulf Watch Alaska monitoring information can be better used to support community information needs. Hoffman presented an overview of the program at the Ocean Fest in Cordova in September 2012 with approximately 220 people in attendance.

Recent examples of resource management use of Gulf Watch Alaska program data include:

1. Humpback whale monitoring data (Straley and Moran) were used to advise the West Pacific Fisheries Management Council on whale predation.

2. Continuous Plankton Recorder data (Batten) were incorporated into NOAA's August 2012 Ecosystem Considerations report for the North Pacific Fisheries Management Council (Batten, S.D. Continuous Plankton Recorder data from the Northeast Pacific, (<http://access.afsc.noaa.gov/reem/ecoweb/Index.cfm>) and into the Canadian Department of Fisheries and Oceans February 2012 "State of the Ocean" meeting and report (State of physical, biological, and selected fishery resources of Pacific Canadian marine ecosystems in 2011, W. R. Crawford and J.R. Irvine, eds. <http://www.pac.dfo-mpo.gc.ca/science/oceans/reports-rapports/state-ocean-etat/index-eng.htm>, DFO Can. Sci. Advis. Sec. Res. Doc. 2012.)

3. Killer whale monitoring data (Matkin) are used for development of NOAA National Marine Fisheries Service stock assessment reports for four killer whale stocks.

l) Information Transfer:

As this was the first year of the Gulf Watch Alaska program, the primary information transfer has been through presentations and by use of humpback whale, killer whale and plankton data for fisheries and protected resource management (see above). The program management team and project PIs made multiple formal and informal presentations throughout the year, as described above and in the individual project summaries. A description of the Gulf Watch Alaska program for the public was included in the Delta Sound Connection science newspaper published annually by the Prince William Sound Science Center. Ten thousand copies of that document were distributed to various locations in south-central Alaska.

m) Budget :

A summary of the program spending to January 31, 2013 is provided below. We are somewhat behind the anticipated spending schedule, due to delays in the start-up of the program and transfer of funding in some cases, as well as individual project issues with equipment purchase and contracts that are described in more detail in the individual budget submissions. We do not anticipate any significant adverse impacts to program milestones, and expect that spending will soon be commensurate with proposed levels.

March 1, 2013

Long-Term Monitoring Year One, Budget vs Actual 2012-13

Principal Investigators and Institution	EVOS Project Number	Activity - short project title	Yr 1 Budget	Yr 1 Actual	Balance Available
		<i>Environmental Drivers Total</i>	584,894.0	393,943.3	190,950.7
		<i>Pelagic Monitoring Total</i>	582,903.0	539,852.3	43,050.7
		<i>Benthic Monitoring Total</i>	303,225.0	156,572.6	146,652.4
		<i>Coordination, Data Management, Outreach and Administration Total</i>	606,141.0	401,572.0	204,569.0
M. Jones, NCEAS	12120120	Collaborative Data Management and Holistic Synthesis of Impacts and Recovery Status Associated with the Exxon Valdez Oil Spill	382,409.0	185,948.0	196,461.0
		Overall Program Total Cost w/o Lingering Oil	2,459,572.0	1,677,888.2	781,683.8
		Lingering Oil Monitoring			
Carls, NOAA	12120114-5	1 - Extending tracking oil composition and weathering in PWS	18,000.0	18,000.0	0.0
Ballachey, NOAA, & Esler, Simon Fraser Univ. & Pacific Wildlife Fdn	12120114-Q	2a & b - Evaluate chronic exposure of sea otters and harlequin ducks in PWS	187,400.0	108,592.3	78,807.7
		Overall Program Total Cost	2,664,972.0	1,804,480.5	860,491.5

Appendix 1. Individual Project Reports

- a) **Project Number—12120114-B**
- b) **Project Title—Integrated program management, data services, science synthesis & outreach**
- c) **Principal Investigator’s Name(s)—Molly McCammon, Kris Holderied, Katrina Hoffman**
- d) **Time Period Covered by the Report—02/01/12 to 01/31/13**
- e) **Date of Report—03/01/13**
- f) **Project Website—<http://www.aos.org/gulfwatchalaska/>**
- g) **Summary of Work Performed—**

Program Coordination and Logistics

During the first year of the program, the administrative lead established the funding contracts for the non-trustee agency principal investigators (PIs). PWSSC monitored project spending, completed its annual audit and extended outreach funding as directed by McCammon and her outreach team. The Program Management Team (PMT) has met approximately monthly and coordinated with investigators, Trustee Council staff and NOAA contract officers as needed. We worked with EVOSTC staff to establish and clarify program reporting requirements. We submitted all financial and project reports to NOAA as required. The Program Management Plan was finalized in May 2012 and all Program PIs are expected to sign and follow it. In addition, all PIs are expected to post copies of their sampling protocols to the Program administrative website.

An LTM PI meeting was held at the January 2012 Alaska Marine Science Symposium (AMSS) in anticipation of the program launch. At the 2013 AMSS, an annual PI meeting was held in conjunction with PIs from the North Pacific Research Board’s GOAIERP program, as well as PIs from other past interdisciplinary research programs in the spill affected region to establish cross-program familiarity, provide opportunities for cross-program leveraging of funds and data, and generate opportunities for communication across the disciplines to support future synthesis activities. PWSSC processed all travel expenses for the annual PI meeting. A PI teleconference was held on May 22, 2012 to check in on year 1 progress and address year 2 planning and other issues. The PMT convened a data management and synthesis and modeling coordination meeting on June 6th, 2012 that included data management, synthesis and modeling PIs, the Program Management Team, ecosystem component leads (Rice, Ballachey, Hopcroft) and the HRM Program Lead (Pegau). A quarterly PI teleconference was held on October 4th, 2012. A full PI meeting was hosted in Anchorage on November 28th and 29th, 2012. All PIs presented project updates and the group participated in a multi-faceted conceptual modeling exercise (see Hollmen report). We also attended the Herring Research and Monitoring PI meetings on April 19, 2012 and November 27, 2012.

Year 2 work plans, budgets and a courtesy progress update were submitted to the EVOSTC in June 2012, as was a semi-annual report on September 1st, 2012 and a Year 1 Annual Program Summary and report on March 1, 2013.

Outreach and Community Involvement

The Outreach and Community Involvement Steering Committee was formed this past year and has met seven times. The Committee includes key outreach staff from AOOS, the PWS Science Center (PWSSC), Kachemak Bay Research Reserve, Alaska SeaLife Center, North Pacific Research Board, COSEE Alaska, NOAA and USGS. AOOS staff developed a basic project website to use until a more sophisticated site can be developed: www.aoot.org/evos-ltm/. AOOS and PWSSC staff also prepared materials for a 2-page insert included in the summer 2012 Delta Connections newspaper that is printed and circulated by the PWSSC throughout PWS.

The Committee identified the primary tasks to be accomplished in Year 1. These included development of a basic suite of outreach materials for the program. AOOS has been overseeing development of these materials, with the committee reviewing content. Completed thus far are a new name (*Gulf Watch Alaska, The Long-term Monitoring program of the Exxon Valdez Oil Spill Trustee Council*), logo, PowerPoint and poster templates, pop-up displays, brochure, presentation folder and bookmarks. Many of these materials were used at the September 15 Ocean Fest in Cordova and at the Alaska Marine Science Symposium January 21-22 in Anchorage. Ocean Fest was attended by over 200 community members in Cordova; PMT member Katrina Hoffman gave a presentation about Gulf Watch Alaska to the general public.

Planning is now underway for the second suite of activities: lecture series and radio programs through the Prince William Sound Science Center; summer lab programs and lectures with the Kachemak Bay Research Reserve; development of a traveling display by the Alaska SeaLife Center; possible Day in our Sound project similar to the Day in our Bay sponsored by the Bristol Bay Native Corporation; and expansion of the program website including project profiles.

The EVOSTC Public Advisory Committee was briefed on these activities at their meeting in July, and the full program PI team at their meeting in Anchorage November 28-30.

h) Summary of Future Work to be Performed—

There are no major changes from the proposed work for Year 2. All program administration, fiscal management, synthesis, data management, and outreach responsibilities will proceed as planned. The Scientific Review Panel will be formed in Year 2.

i) Coordination/Collaboration

The PMT has maintained close communication with the project lead for the Herring Research and Monitoring program. We have also hosted a coordinated meeting with NPRB GOAIERP principal investigators.

j) Community Involvement/TEK and Resource Management Applications –

The Outreach team is developing opportunities for community involvement and incorporation of TEK as described in the original proposal.

k) Information Transfer

Hoffman gave a Gulf Watch Alaska presentation to 221 members of the general public at Ocean Fest in Cordova, Alaska on September 15, 2012. Holderied gave a Gulf Watch Alaska presentation at the Alaska Marine Science Symposium in January 2013. Program description publications and bookmarks were printed (see Outreach section). The science coordination effort has generated preliminary synthesis graphs (see Holderied report).

I) Budget

**EXXON VALDEZ OIL SPILL TRUSTEE COUNCIL
ANNUAL PROGRAM REPORT YEAR 1**

Budget Category:	Proposed Year 1	Actual Year 1	TOTAL Difference
Personnel	\$118,800	\$113,078	\$5,722
Travel	\$48,300	\$5,683	\$42,617
Contractual	\$69,500	\$20,983	\$48,517
Commodities	\$5,000	\$209	\$4,791
Equipment	\$0	\$0	\$0
Other (Contractual in EVOS Budget)	\$0	\$0	\$0
Indirect Costs (<i>will vary by proposer</i>)	\$0	\$0	\$0
SUBTOTAL	\$241,600	\$139,953	\$101,647
General Administration (9% of subtotal)	\$21,744	\$12,596	\$9,148
PROJECT TOTAL	\$263,344	\$152,549	\$110,795
Other Resources (Cost Share Funds)	\$0	\$0	\$0

COMMENTS: While the budget is slightly underspent for Year 1, we anticipate spending to proceed at predicted levels in future years.

FY12

**Program Title: 12120114-B, LTM -
Coordination and Logistics
Team Leader: Hoffman**

SUMMARY

- a) Project Number—12120114-D
- b) Project Title—Data Management
- c) Principal Investigator’s Name(s)—Rob Bochenek
- d) Time Period Covered by the Report—02/01/12 to 01/31/13
- e) Date of Report—03/01/13
- f) Project Website—<http://www.aos.org/gulfwatchalaska/>

g) Summary of Work Performed—

During the first year of the EVOS Long Term Monitoring Program - Data Management project investigators have been focused on establishing protocols for data transfer, metadata requirements and initiating the data salvage effort. The AOOS ocean workspace has been rolled out to PIs and their user and group profiles have been created. Investigators have been meeting via webex periodically with Matt Jones and other NCEAS staff to coordinate activities. PIs have participated in several PI meetings and are coordinating activities between the Herring and LTM programs. In addition, several training seminars have been held via webinars and PIs are beginning to use the system to organize and consolidate their project level data. Software engineers at Axiom have also been working to support the workspace, resolving bugs and implementing new functionality in response to user feedback. The data salvage effort has begun with prioritization from lead investigators, NCEAS Staff and engagement of the Cordova Alaska Department of Fish & Game.

Investigators have addressed the objectives of the original proposal in the following ways:

Objective 1: Provide data management oversight and services for EVOS LTM project team data centric activities which include data structure optimization, metadata generation, and transfer of data between project teams.

- Deployed, configured and facilitated the use of a web based data management and scientific collaboration tool (AOOS Ocean Workspace) to support data submission, metadata generation and foster integration between PWS Herring Program Investigators.
- Collaboration and coordination with NCEAS staff on historical data salvage for data synthesis efforts. Establishment of EVOS Historic Data Salvage group in AOOS Ocean Workspace.
- Data transfer from PIs has initiated with review by data management staff.

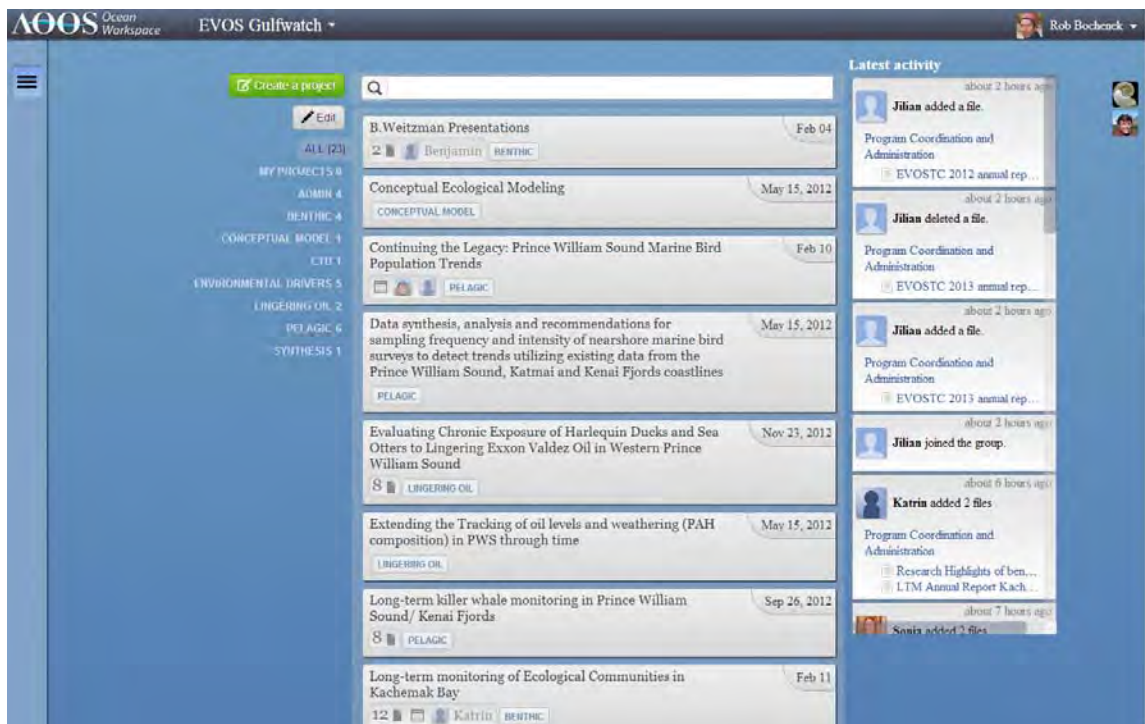

Figure 1.

Screenshot of LTM/Gulfwatch Program Workspace group and interface.

Objective 2: Consolidate, standardize and provide access to study area data sets that are critical for retrospective analysis, synthesis and model development.

- Several baseline observational data sets and GIS resources have been consolidated and integrated into the AOOS data system to be exposed through the emerging Gulfwatch Geospatial Data Portal.
- Established data exchange mechanisms with KBNERR and the USFWS Refuge (Homer, AK) for transfer and staging of their historic datasets to workspace staging areas.
- Re-established data exchange relationship with ADF&G and created an ADF&G dedicated AOOS Ocean Workspace Group for the secure sharing of data with LTM/Gulfwatch Investigators.

Objective 3: Develop tools for user groups to access, analyze and visualize information produced or processed by the LTM effort.

- Scoping has commenced for the Gulfwatch data portal visualization tool through engagement of lead Gulfwatch PIs.

Objective 4: Integrate all data, metadata and information products produced from this effort into the AOOS data management system for long-term storage and public use.

- AOOS has provisioned capacity and storage space for archiving all LTM/Gulfwatch datasets and electronic materials.
- AOOS is working to develop methods to publish and make publicly available datasets and metadata that have been staged in the AOOS Ocean Workspace.

h) Summary of Future Work to be Performed—

Investigators will continue work on the schedule outlined in the original proposal. Specifically, this will focus on facilitating the transfer, documentation and review of year 1 sampling activities, coordinating with NCEAS staff on the historical data salvage and deploying the Gulfwatch Geospatial Data Portal.

i) Coordination/ Collaboration—

This project is focused on providing a framework for cross-disciplinary integration through the facilitated use of a web based data management tool (AOOS Ocean Workspace). This platform will provide scientists and administrators increased transparency and improved access to LTM/Gulfwatch data sets and other contextual information. NCEAS has also used the workspace to stage data for their synthesis effort and data salvage activities.

j) Community Involvement/ TEK and Resource Management Applications—

Several presentations were made to various community and research groups during the last year (CIRCAC, GOAIERP, and Arctic Eis) discussing the approach and results of this project.

k) Information Transfer—

No new data sets were produced from this effort but a large number of retrospective and historic datasets have been aggregated and staged on the AOOS Ocean Workspace in coordination with NCEAS. The ultimate goal being to increase information transfer between Gulfwatch investigators to increase integration and support synthesis.

l) **Budget**—No differences or problems with previous or out year budgets.

Budget Category:	Proposed Year 1	Actual Year 1	TOTAL Difference
Personnel	\$138,450	\$129,893	\$8,557
Travel	\$0	\$0	\$0
Contractual	\$0	\$0	\$0
Commodities	\$0	\$0	\$0
Equipment	\$5,100	\$0	\$5,100
Other	\$0	\$0	\$0
Indirect Costs (<i>will vary by proposer</i>)	\$31,431	\$26,482	\$4,949
SUBTOTAL	\$174,981	\$156,375	\$18,606
General Administration (9% of subtotal)	\$15,748	\$14,074	\$1,675
PROJECT TOTAL	\$190,729	\$170,449	\$20,281
Other Resources (Cost Share Funds)	\$0	\$0	\$0

COMMENTS: Invoices received to PWSSC through period ending 12/31/2012. Budget revised between 12120120, Collaborative Data Management and 120120114-D, Data Management as per Gulf Watch Lead Team. Original Budget 149,994, current 174,981. Difference = 24,987

FY12

Program Title: 12120114-D, Data Management
Team Leader: Bochenek

SUMMARY

- a) **Project Number**—12120114-H
- b) **Title**—Science Coordination and Synthesis for the Long Term Monitoring Program
- c) **Principal Investigators**— Kris Holderied (NOAA Kasitsna Bay Laboratory)
- d) **Time Period Covered by Report**— 11/1/11 to 1/31/13
- e) **Date of Report**—3/1/13
- f) **Project Website**—www.aos.org/gulfwatchalaska

g) Summary of work performed—

Science coordination was the primary focus of this project during the first Gulf Watch Alaska ecosystem monitoring program year, as expected, with an increase in science synthesis-related efforts starting with the November 2012 annual principal investigator (PI) meeting. The year 1 monitoring program progress and results have been summarized in the progress status report summary portion of the annual report.

Below is a summary of science coordination and synthesis work performed in year 1 by project objective.

Objective 1. Improve communication, data sharing and coordinated field work planning between PIs of the individual monitoring projects, as well as with other agencies and research organizations

Annual principal investigator (PI) meetings for Gulf Watch Alaska were held in Anchorage in November 2011 and November 2012. Shorter in-person meetings were held with PIs, NOAA contract staff and EVOS Trustee Council staff at the Alaska Marine Science Symposium in January 2012 and January 2013. Additional PI meetings were held via teleconference in May 2012 and October 2012. Investigators from every project attended the in-person annual meetings and most investigators attended the teleconference meetings. PI meeting agendas, summaries and other materials are posted on the Program website. The program's Science Coordinating Committee has also met routinely via teleconference, in addition to the PI meetings, in order to plan PI meetings, develop the Program Management Plan, provide input on needed data management services, develop the year 2 work plan, discuss plans for the Science Technical Oversight Committee and address on-going program coordination issues.

To ensure consistency in the monitoring program over time, all PIs are preparing written sampling protocols for their monitoring projects and submitting them to the program management team. All protocols will be made available to the program PIs via the Ocean Workspace website. The sampling protocols will supplement the required metadata submitted with monitoring data. We have supported efforts by the data management team to develop and encourage PI use of the Ocean Workspace as a primary mechanism for information sharing across the program. The data management team also developed an initial interactive Google document to share and update field survey plans between PIs.

Objective 2. Improve and document integration of science monitoring results across the LTM program - working with the PIs, data management and modeling teams as well as other agencies and research organizations.

PIs with the Prince William Sound/Gulf of Alaska (Ballachey) and Kachemak Bay (Konar/Iken) benthic monitoring projects have closely coordinated on nearshore monitoring protocols. Kris Holderied participated in several coordination meetings for the benthic monitoring component, in person at the Alaska Marine Science Symposium and via teleconference. Plankton sampling protocols have been closely coordinated between the PWS (Campbell) and Cook Inlet (Doroff/Holderied) oceanographic monitoring projects and zooplankton analysis for the Cook Inlet project will be conducted by Campbell's group in order to ensure consistency between the

two groups. Investigators from different projects have participated in each other’s research cruises, beyond what was originally proposed, in order to increase consistency in sampling across the different sites and to leverage scientific capabilities across the integrated team. One example was a Cook Inlet PI (Doroff) joining the PWS nearshore benthic monitoring cruise to provide additional sea otter monitoring capabilities. These expanded collaborations have been an immediate benefit from the increased communication between investigators made possible by the integrated program. The Cook Inlet oceanography monitoring project PIs are also collaborating with the U.S. Fish and Wildlife Service At-Sea Observer program to host a USFWS seabird observer on the seasonal lower Cook Inlet surveys, benefiting both the Gulf Watch and USFWS programs.

We are developing a variety of tools to communicate the scope and timing of the monitoring effort between program investigators and to a broader audience of resource managers, other researchers and the general public. Figure 1 provides an example of a table developed to more easily visualize the 2012 field sampling efforts, across different disciplines.

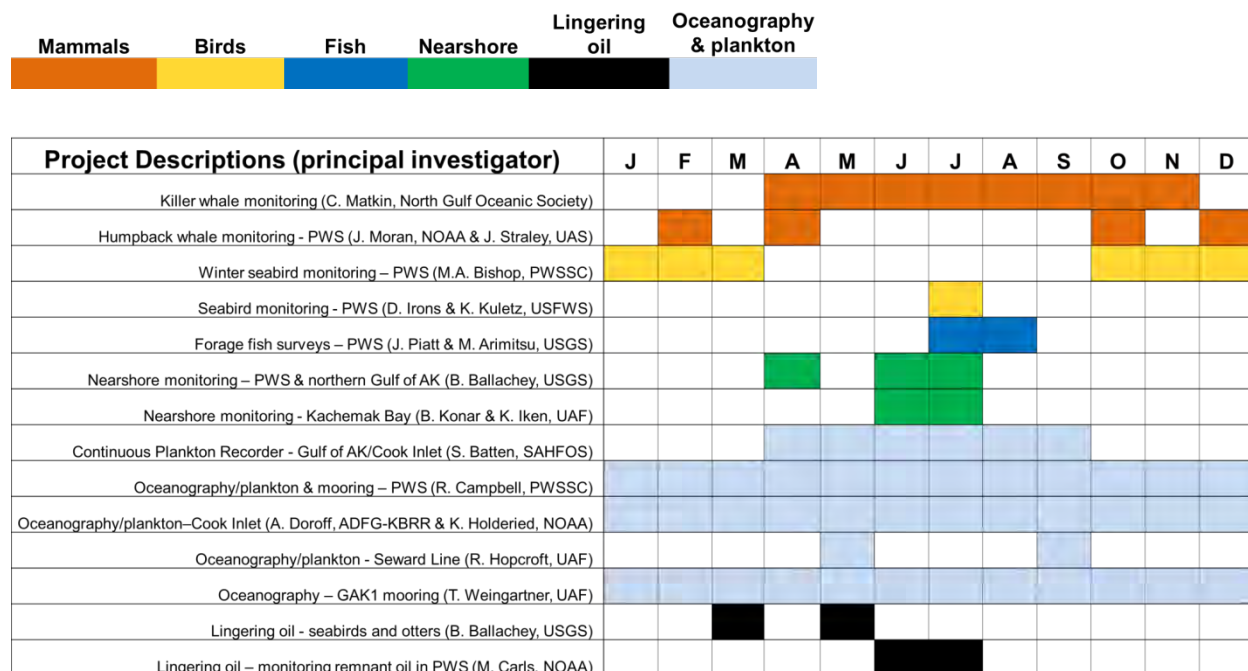

Figure 1. 2012 field sampling program and associated principal investigators. Legend at top indicates the type of sampling associated with each color.

Objective 3. Improve communication of monitoring information to resource managers and the public through data synthesis and visualization products and tools – working with the data management, conceptual ecological modeling and outreach teams, as well as other agencies and research organizations.

A primary focus of the November 2012 annual PI meeting was on how to improve the use of individual project data and cross-disciplinary information products by resource managers. In

addition to project updates, all PIs reported on how their monitoring data is currently being used to support resource management and on additional ways in which it could be used in the future. Recent examples of resource management use of Gulf Watch Alaska program data include the following:

1. Humpback whale monitoring data (Straley and Moran) were used to advise the West Pacific Fisheries Management Council on whale predation.
2. Continuous Plankton Recorder data (Batten) were incorporated into NOAA's August 2012 Ecosystem Considerations report for the North Pacific Fisheries Management Council (Batten, S.D. Continuous Plankton Recorder data from the Northeast Pacific, <http://access.afsc.noaa.gov/reem/ecoweb/Index.cfm>) and into the Canadian Department of Fisheries and Oceans February 2012 "State of the Ocean" meeting and report (State of physical, biological, and selected fishery resources of Pacific Canadian marine ecosystems in 2011, W. R. Crawford and J.R. Irvine, eds. <http://www.pac.dfo-mpo.gc.ca/science/oceans/reports-rapports/state-ocean-etat/index-eng.htm>, DFO Can. Sci. Advis. Sec. Res. Doc. 2012.)
3. Killer whale monitoring data (Matkin) are used for development of NOAA National Marine Fisheries Service stock assessment reports for four killer whale stocks.

In order to improve cross-program integration and support development of conceptual ecosystem models for the Gulf Watch Alaska program, the annual PI meeting included overviews of conceptual ecosystem modeling and decision support tools. Breakout sessions were conducted to start to refine a conceptual ecosystem framework for the Gulf of Alaska ecosystem, building on past efforts. PIs also tested a process that defines linkages between ecosystem components and then ranks the level of understanding that experts have of the different linkages.

Preliminary efforts have been started to compile data visualizations from across the Gulf Watch Alaska program and to develop improved data visualizations for a variety of stakeholders, with an emphasis on meeting the needs of resource managers and providing useful information to local communities. Three different examples of time series visualizations for similar types of data are provided below. Figure 2 shows standard time series graphs of water properties (salinity, temperature, pH) from the Kachemak Bay Research Reserve water quality monitoring station at the Seldovia, Alaska harbor, with the seasons color-coded to aid in visual interpretation. This type of graph is geared toward a more expert audience. Figure 3 also portrays a water temperature time series, this time generated from the upper water column along the Seward Line oceanography stations. While it is also visually easy to interpret, it is also geared toward a knowledgeable audience. By contrast, Figure 4 is aimed at a general audience and uses color and simple terms to communicate information about how monthly water temperatures have changed at Seldovia harbor from 2004 to 2012. A key goal of the science synthesis effort is to improve how the monitoring data from the program is actually used and visualizations are an important part of that effort.

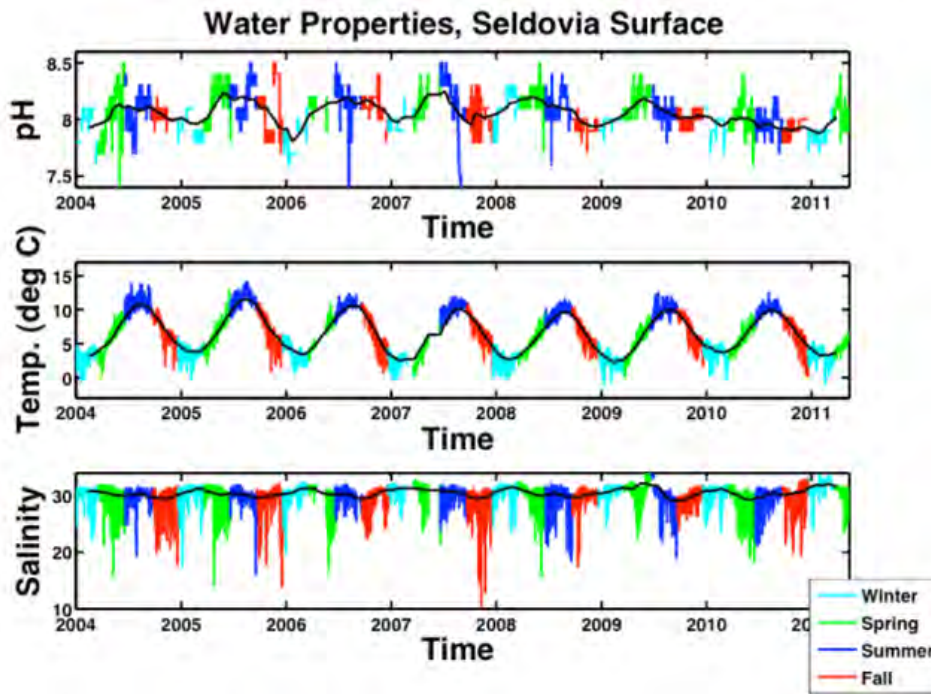

Figure 2. Time series of salinity (bottom), temperature (middle) and pH (top) from the Kachemak Bay Research Reserve water quality monitoring station at Seldovia Harbor from 2004 to 2011. Colors indicate the season and the black line is a 3-month running average.

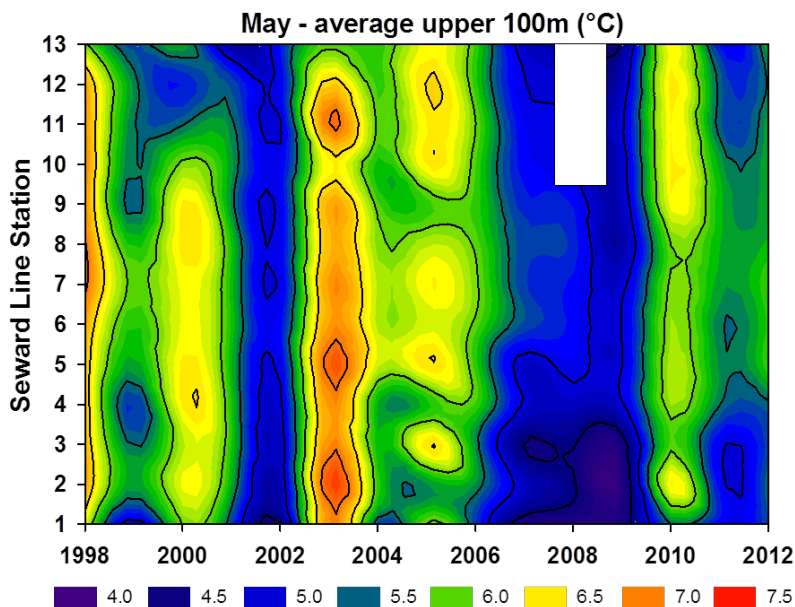

Figure 3. Average May water temperatures in the upper 100 meters along Seward Line stations (top to bottom) from 1998-2012 (left to right). Station 1 (at bottom of graph) is closest to shore. Colors indicate temperature. The Seward Line is a transect of oceanographic and plankton sampling stations running from just outside Resurrection Bay offshore to the edge of the Gulf of Alaska shelf. Graphic courtesy of Russ Hopcroft.

Seldovia Relative Monthly Temperature

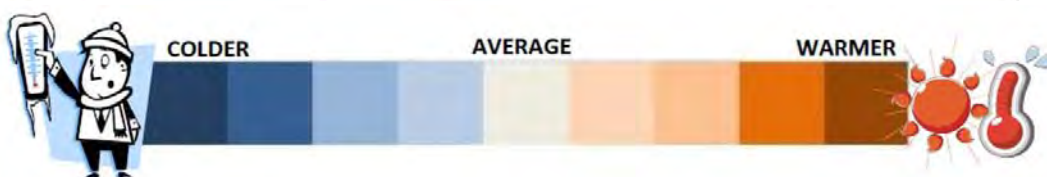
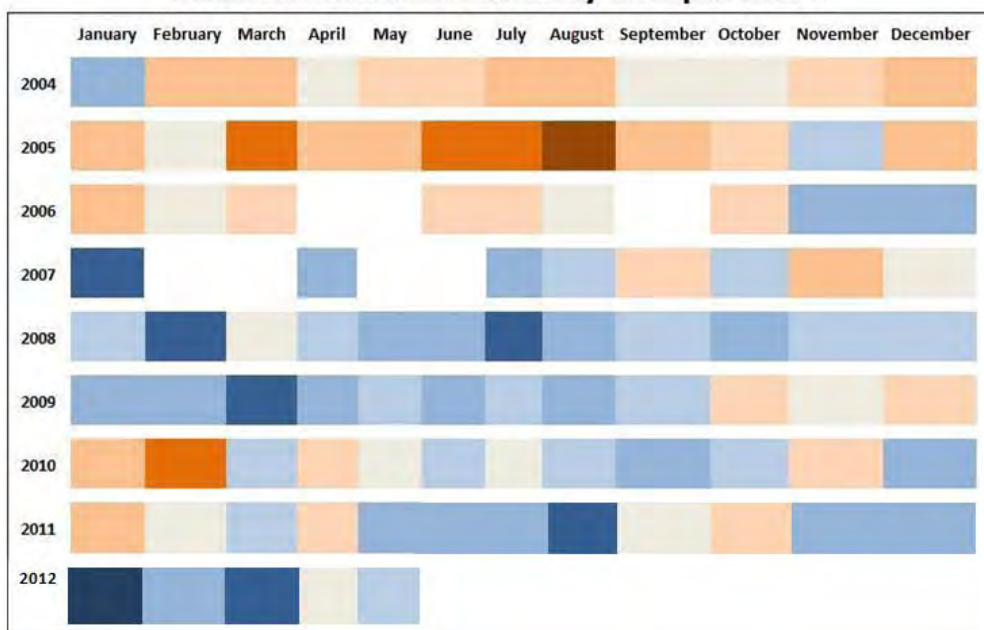

Figure 4. Visualization of surface water temperature anomaly time series from Seldovia harbor, in Kachemak Bay Alaska. The anomaly value for each month is calculated as the difference between the monthly mean and the 2004-2012 mean for that month. Input data is collected every 15 minutes from a Kachemak Bay Research Reserve data sonde. This visualization is designed to reach a general audience and therefore uses color and simple terms, rather than referencing calculations of means and standard deviations.

Issues. We were not able to hire full-time contract staff for science coordination support as quickly as we wanted to, due to initial delays in obtaining funding, delays in the carryover of program funds between federal fiscal years, and to changes in contractor personnel. The contract for a science coordinator was established by NOAA in July 2012, with part-time support provided in fall 2012 for the November 2012 annual program meeting and the 2013 Alaska Marine Science Symposium. Kris Holderied provided additional in-kind coordination efforts for the program in year 1 to maintain progress. The delay in hiring a full-time coordinator also delayed purchase of supplies and computer equipment, travel costs, and new office rental expenses. Computer, commodities and travel costs will now be made in year 2 and we propose to use contract costs saved on office rental in year 1 for contract services to develop synthesis products and printing in year 2.

h) Summary of future work to be performed—

A full-time science coordinator is expected to start in March 2013 and additional contract services to develop cross-program information products will be obtained in year 2, under the NOAA science coordination support contract. We will assist NCEAS in their historical data synthesis and coordinate with the Gulf of Alaska historic data synthesis efforts being done currently by the NPRB GOAIERP. We have initiated discussions with the NPRB GOAIERP lead PIs on collaborating on a joint scientific journal special issue focused on Gulf of Alaska research and monitoring, with an initial goal of preparing the issue by the end of 2013, which is earlier than such an issue had been originally planned. The papers prepared for this special issue would also inform the EVOS TC year 3 joint workshop between the Gulf Watch Alaska and Herring Research and Monitoring programs. Other future work is as originally proposed, with the following milestones in next six months.

Milestones:

1. Update field work schedule by May 2013.
2. Develop year 3 workplan with project management team and PIs.
3. Develop an example interactive data visualization tool in coordination with data management and conceptual ecological modeling teams.
4. Assist in initial planning of joint Gulf Watch Alaska-Herring Research and Monitoring programs workshop

i) Coordination/Collaboration—

The primary goals of the LTM program science coordination and synthesis efforts are to: 1) support coordination between the EVOSTC-funded LTM projects, 2) facilitate coordination with the EVOSTC-funded herring program, and 3) support collaborations with other efforts, including state and federal agency operations and research programs funded by other organizations such as NPRB. Please see above sections for coordination and collaboration details.

j) Community Involvement/TEK and Resource Management Applications—

We have assisted the outreach team in development of outreach materials for the community, including a 2-page article in the *Delta Sound Connections* newspaper on both the Gulf Watch Alaska and Herring programs. Public briefings on the program have been provided at the 2012 Kachemak Bay Science Conference in March 2012 and to the Kachemak Bay Research Reserve's Community Council in December 2012. See sections above for recent resource management applications of Gulf Watch Alaska program data.

k) Information Transfer—

Multiple public presentations were made in a variety of venues on the integrated Gulf Watch Alaska program during year 1. Kris Holderied gave Gulf Watch Alaska program overview talks at the 2011 National Park Service Alaska Science Symposium (November 2011), 2012 Alaska Marine Science Symposium (AMSS) (January 2012), 2012 American Fisheries Society, Alaska chapter meeting (October 2012), , and gave a poster presentation at the 2013 AMSS (January 2013). See below for details. She also gave a talk at a 2013 AMSS evening workshop on Gulf of

Alaska research jointly organized by the Gulf Watch management team, the EVOS TC Herring Research and Monitoring program and the North Pacific Research Board Gulf of Alaska Integrated Ecosystem Research Program. Multiple PIs also gave presentations at the 2013 AMSS on individual project results (see other project reports for details).

Holderied, K. Nov 2011. National Park Service Alaska Science Symposium. Moving Towards the Next Phase of Monitoring after the Exxon Valdez Oil Spill: A New Integrated Program. Oral presentation (Holderied).

Holderied, K., M. McCammon, and K. Hoffman. Jan 2012. Alaska Marine Science Symposium. Long-Term Monitoring of Marine Conditions and Exxon Valdez Oil Spill Injured Resources: A New Integrated Program. Oral presentation (Holderied).

McCammon, M., W. S. Pegau, K. Holderied, B. Ballachey, T. Weingartner, R. Hopcroft, and S. Rice. Oct 2012. American Fisheries Society, Alaska chapter meeting. From Spilled Oil to Long Term Ecosystem and Herring Monitoring. Oral presentation (Holderied).

Holderied, K., M. McCammon, K. Hoffman, S. Rice, B. Ballachey, T. Weingartner, and R. Hopcroft. Jan 2013. Alaska Marine Science Symposium. Gulf Watch Alaska – Ecosystem monitoring at the intersection of spilled oil and climate change. Poster presentation (Holderied).

I) Budget—

**EXXON VALDEZ OIL SPILL TRUSTEE
COUNCIL
ANNUAL PROGRAM REPORT YEAR 1**

Budget Category:	Proposed Year 1	Actual Year 1	TOTAL Difference
Personnel (contract)	\$90,000	\$90,000	\$0
Travel	\$10,800	\$4,908	\$5,892
Contractual	\$7,500	\$0	\$7,500
Commodities	\$1,000	\$0	\$1,000
Equipment	\$4,000	\$0	\$4,000
Indirect Costs (<i>will vary by proposer</i>)			\$0
SUBTOTAL	\$113,300	\$94,908	\$18,392
General Administration (9% of subtotal)	\$10,200	\$0	\$10,200
PROJECT TOTAL	\$123,500	\$94,908	\$28,592
Other Resources (Cost Share Funds)	\$0	\$0	\$0

COMMENTS: Personnel costs are for contract staff under a NOAA contract. Planned travel costs include contract staff travel which is also in the contract, but will be accomplished in Year 2 due to delay in start of full-time science coordinator. Total funds obligated to contract were \$96K. Planned contractual (\$7.5K for office rental, software licenses), commodities (\$1K), equipment (\$4K) and G&A (\$10.2) also moved to Year 2 (FY13) due to delays in funding transfers and in science coordinator hiring. Propose using contract funds for Year 1 office space rental for contract services for synthesis products (\$2.5K) and printing (\$1K). In-kind salary contribution for K. Holderied coordination efforts in Year 1 is \$25K.

FY12

Program Title: Science Coordination & Synthesis
Team Leader: Kris Holderied, NOAA
Kasitsna Bay Laboratory

SUMMARY

- a) **Project Number**—12120114-I
- b) **Project Title**— Long-term Monitoring: Synthesis and Conceptual Modeling—Conceptual Ecological Modeling
- c) **Principal Investigator's Name(s)** – Tuula Hollmen
- d) **Time Period Covered by the Report** – 02/01/12 to 01/31/13
- e) **Date of Report** – March 1, 2013
- f) **Project Website** – N/A
- g) **Summary of Work Performed**—

Work on development of conceptual ecological models began after contracts were in place on April 13, 2012. Tasks set forth for the first year of our project included: identification of data and system components for the conceptual modeling efforts, assembly of a core modeling team, development and review of modeling goals with the principal investigators, and preparation for the November principal investigator meeting to elicit input for construction of draft conceptual ecological models.

Initially, information about previous conceptual modeling efforts relating to our study area and objectives was compiled and reviewed, and evaluation of best-suited modeling tools for our program purposes was conducted. The approach taken involved drafting of a parsimonious overall conceptual model to describe current understanding of the structure and dynamics of our entire study area, with goals to further develop a suite of submodels that address specific scientific questions and management linkages of our program.

A one-day modeling session was included in the agenda of the annual principal investigator meeting held in November 2012. The modeling session began with a series of introductory presentations focusing on ecosystem modeling tools, conceptual ecological models, and decision support tools for resource management. The introductory presentations were followed by a half-day breakout session. In this session, the principal investigators worked on two exercises to gather expert input into the development of conceptual ecological models. The first exercise focused on the development of a general North Gulf of Alaska ecosystem model. The primary objective of this exercise was to develop a minimally but sufficiently detailed conceptual model which identifies: a) natural and anthropogenic forcing factors, b) key biophysical processes and biophysical components to monitor which either play a central role in the functioning of the system or are of special interest to stakeholders, and c) linkages between model elements in our study system. The principal investigators, working in smaller break out groups, provided their expert input by expanding or reducing a starting set of conceptual model elements, provided by the modeling team, and translating the outcome list to a conceptual model diagram. Input from this session is being analyzed and will be used to develop the draft conceptual ecosystem model as outlined in the study plan.

The second exercise focused on eliciting principal investigator expert opinion about strength of linkages among ecosystem components. A novel linkage rating tool was developed and tested by the principal investigators. Feedback received about the tool will be used to further develop linkage assessment tools for conceptual ecosystem modeling, and feedback on linkages will be incorporated into our ecological models and updated as knowledge about system processes increases throughout the program.

h) Summary of Future Work to be Performed—

No changes to the original work plan are expected. Key milestones in the upcoming six months include:

- *Design draft conceptual models*
- *Continue development of interactive/data visualization tools*

i) Coordination/ Collaboration—

Coordination on synthesis task with Kris Holderied continued throughout the reporting period. Input from Principal Investigators was elicited during modeling working sessions at the annual principal investigator meeting in November 2012.

j) Community Involvement/TEK and Resource Management Applications—

We elicited principal investigator input about management applications of research being conducted in our program, and incorporated management linkages into planning of submodels.

k) Information Transfer—

Presentations were delivered at the annual principal investigator meeting. Principal investigator attended the 2013 Alaska Marine Science Symposium.

I) Budget—

- A detailed accounting of the project spending for the fiscal year October 1, 2011 - September 30, 2012 is included on the following page.
- No budget changes have been made and there are no new in-kind or matching funds from non-Trustee Council sources for this project. A comparison of the actual funds spent versus those originally requested and approved by the Council is shown on the following page. Spending to date on the Contractual line is below due to a delay in the contracting process with the University of Alaska Fairbanks, which will cover the PI's time for this project.

Budget Category:	Proposed Year 1	Actual Year 1	TOTAL Difference
Personnel	\$10,000	\$3,688	\$6,312
Travel	\$5,760	\$3,584	\$2,176
Contractual	\$38,400	\$502	\$37,898
Commodities	\$4,000	\$0	\$4,000
Equipment	\$0	\$0	\$0
Other	\$0	\$0	\$0
Indirect Costs (<i>will vary by proposer</i>)	\$18,100	\$2,562	\$15,538
SUBTOTAL	\$76,260	\$10,336	\$65,924
General Administration (9% of subtotal)	\$6,863	\$930	\$5,933
PROJECT TOTAL	\$83,123	\$11,266	\$71,857
Other Resources (Cost Share Funds)	\$0	\$0	\$0

COMMENTS: Invoices received to PWSSC through period ending 12/31/2012.

FY12

**Program Title: 12120114-I,
Conceptual Ecological Modeling
Team Leader: Tuula Hollmen**

SUMMARY

- a) **Project Number**—12120120
- b) **Project Title**—Collaborative Data Management and Holistic Synthesis of Impacts and Recovery Status Associated with the Exxon Valdez Oil Spill
- c) **Project Investigator's Name(s)**—Matthew Jones
- d) **Time Period Covered by the Report**—01/02/12 to 31/01/13
- e) **Date of Report** – March 1, 2013
- f) **Project Website** –

The prototype site for collated data that has been fully captured is:

<http://evos.nceas.ucsb.edu/evos>

These data also get deposited in the AOOS Ocean Workspace.

We operate a task-tracking site for project management here:

<https://projects.nceas.ucsb.edu/evos/projects/lrm-hrm/issues>

All data collation activities are tracked with tickets for every data set and project to be resolved.

g) Summary of Work Performed –

Project work is proceeding on schedule on both the historical data salvage effort and the design of data management tools for the project. Work on this project was started in June 2012 with the hire of Sarah Clark as the Projects Data Coordinator and in July 2012 with the beginning of design activities between NCEAS and Axiom. We hired three part-time student interns to assist in the historic data salvage efforts who started in November, 2012.

Data Collation for Historical EVOS data

We created a historic data manifest¹ listing all EVOSTC-funded projects and some of the data sets associated with those projects. Salvaging efforts have uncovered 463 relevant research project clusters funded by the Exxon Valdez Oil Spill Trustee Council since 1989, covering various time spans, and within these projects 176 potential data sets have currently been identified; many more will be identified as we continue to contact investigators. The large number of projects, and the long-time period since many were funded, will prevent us from salvaging all of the EVOSTC data, so we conducted a prioritization activity to determine what the high priority data sets are to salvage. Gulfwatch PIs were surveyed at the November 2012 PI meeting to help assess and prioritize historic data for order of salvaging, and a rating of high, medium, or low was assigned to each. These priorities for the first pass are based on 1) data that constitute a long time series and so are valuable from a historical perspective, 2) data that are at risk of loss due to retirement or other factors, and 3) data that are easily accessible. One major challenge that we are experiencing (and was expected) is lack of response from contacted investigators, and resistance to putting time into providing historical data from those that we do reach. High priority projects have been the focus of the last 2 months work. However, due to lags in acquiring data, we plan to contact the remaining PIs and salvage data based on availability as well as priority.

¹ https://docs.google.com/spreadsheet/ccc?key=0Aj_fajgYv6y6dGhlykEyamp5Xzk1WFBIVk9vZU93cVE#gid=16

As shown in Table 1, we have contacted 84 of 222 PIs, heard back from 49 and received data from 12 for a total of 61 data sets (37 of which are data from the Auke Bay Laboratory hydrocarbon database). All data received is or will be formatted into CSV files and archived both on the AOOS Ocean Workspace and publicly in the DataONE network. Metadata is written in XML format using the software Morpho, which is then also stored with the archived data.

Data Collation Summary Table (1)

	2012 <i>Jul</i>	2012 <i>Aug</i>	2012 <i>Sep</i>	2012 <i>Oct</i>	2012 <i>Nov</i>	2012 <i>Dec</i>	2013 <i>Jan</i>	2013 <i>Feb</i>	<i>No Date</i>	<i>Total</i>
I. Number of PIs contacted										
Outreach Emails	10	9	4	7	6	10	26	61	2	135
Responses	4	5	6	4	5	1	20	19	3	67
II. Amount of data received										
Data Files Received	1	5	1	2	3	4	42	3	0	61
Finished Packages	0	0	0	0	1	2	6	2	0	11

Data replication and preservation via DataONE

Preserving data requires archiving data across multiple different institutions, each of which is independently funded to allow for the maximum chance that archived data will persist into the future. The DataONE (<http://dataone.org>) network of data repositories was established to facilitate interoperability among diverse data repositories (Member Nodes in DataONE vernacular), and to promote data preservation and access through data replication among disparate repositories. We have developed a prototype Member Node for GulfWatch (<http://evos.nceas.ucsb.edu/evos>) to test interoperability of the AOOS Ocean Workspace platform with the broader community of repository efforts represented by DataONE. This GulfWatch Member Node houses a copy of all science metadata and data that has been collated by the historical data salvage team, and these data objects are also archived in the AOOS Ocean Workspace. This allows GulfWatch data to be discoverable and accessible from the DataONE network, and makes it available to software tools designed to work with DataONE.

Data management and analysis tools

Documenting historical data collected by a wide variety of investigators requires a mature and flexible set of data management and analysis tools. Towards that end, we have worked on two tools for use within GulfWatch: Morpho and Kepler.

Morpho is a general-purpose, open source, data management and metadata editing application. We have contributed to the development of extensions of Morpho that allow it to interact with DataONE Member Nodes to store and access data and metadata. This '2.0' release of Morpho will be released to the public in February 2013, and has been in extensive use for documenting and managing GulfWatch data sets by the Project Data Coordinator and student interns.

Kepler is a scientific workflow system that allows scientists to document and archive analyses in models in a graphical system that is easy to understand and reproduce. We have developed prototype extensions of Kepler allowing the workflow environment to access data in the

GulfWatch Member Node system. We have also prototyped workflows that illustrate how we can access GulfWatch data from within Kepler and use it in analyses and models that operate on the data (Figure 1).

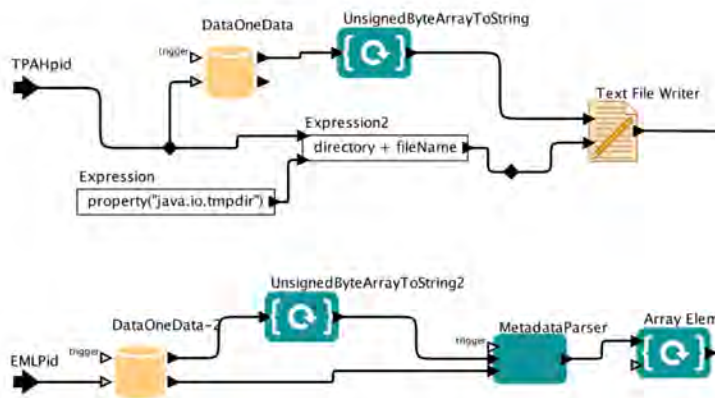

Figure 1: A Kepler scientific workflow showing components that access data from the GulfWatch Member Node, used in further data processing downstream in the workflow.

The system will be further developed to allow the summarization and web posting of data synopses for the diverse historical data that we are collating under GulfWatch, and a formal release of Kepler supporting access to data in DataONE repositories will be created in the next year.

h) Summary of Future Work to be Performed –

There are no changes to the proposed work, but as discussed in earlier interim reports, we expect the expenditures for software development to be delayed into years 2 and 3 as we try to plan and coordinate with related efforts on the Ocean Workspace. We expect to continue the work on historical data collation, develop tools for managing, analyzing, and visualizing historical data, and initiate the development of two synthesis working groups to be conducted starting during the third year of the project.

i) Coordination/Collaboration –

M. Jones attended the initial LTM PI meeting in Anchorage in November 2011, and M. Jones and S. Clark attended the GulfWatch PI meeting in November, 2012. M. Jones also attended an additional organizational meeting of the Gulfwatch PIs in Anchorage in June, 2012.

M. Jones and R. Bochenek began a series of design discussions to plan research data management infrastructure for the project (meeting roughly every other week on Tuesdays by video conference since last fall), and M. Jones and R. Bochenek planned and created several project management tools, including shared mailing lists, web sites, publication sharing sites, and issue tracking sites. Tracking of data set collation is occurring through a ticketing system used to keep track of all project activities².

² <https://projects.nceas.ucsb.edu/evos/projects/lrm-hrm/issues>

j) **Community Involvement/TEK and Resource Management Applications –N/A**

k) **Information Transfer –**

- No publications were produced during the reporting period
- No conference and workshop presentations and attendance during the reporting period
- Data and/or information products developed during the reporting period include 11 published data sets from the historical data collation effort, which are distributed via the GulfWatch Member Node and the AOOS Ocean Workspace. An additional 50 data packages are in the process of being organized, documented and released, with data files stored both on the GulfWatch Member Node and in the AOOS Ocean Workspace, and more are being identified daily as PIs respond to our contacts.

l) **Budget –**Funding expected as previously described, but with delayed spending as agreed during earlier interim project reports.

**EXXON VALDEZ OIL SPILL TRUSTEE COUNCIL
ANNUAL PROGRAM REPORT YEAR 1**

Budget Category:	Proposed Year 1	Actual Year 1	TOTAL Difference
Personnel	\$294,215	\$139,891	\$154,324
Travel	\$2,784	\$1,264	\$1,520
Contractual		\$0	\$0
Commodities	\$6,500	\$7,114	(\$614)
Equipment		\$0	\$0
Indirect Costs (<i>will vary by proposer</i>)	\$78,910	\$37,679	\$41,231
SUBTOTAL	\$382,409	\$185,948	\$196,461
General Administration (9% of subtotal)	\$34,417	\$16,735	\$17,681
PROJECT TOTAL	\$416,826	\$202,683	\$214,142
Other Resources (Cost Share Funds)	\$0	\$0	\$0

COMMENTS: Invoices received to PWSSC through period ending 12/31/2012. Budget revised between 12120120, Collaborative Data Management and 120120114-D, Data Management as per Gulf Watch Lead Team. Original Budget 407,396, current 382,409. Difference = <24,987>

FY12

**Program Title: 12120120,
Collaborative Data Management and
Holistic Synthesis
Team Leader: Matt Jones**

SUMMARY

a) **Project Number— 12120114-L**

- b) **Project Title**—Long-Term monitoring of ecological communities in Kachemak Bay: a comparison and control for Prince William Sound
- c) **Principal Investigator**— Brenda Konar (UAF), Katrin Iken (UAF), Angela Doroff (KBNERR)
- d) **Time Period Covered by the Report**—02/01/12 to 01/31/13
- e) **Date of Report**— 02/15/13
- f) **Project Website**— N/A
- g) **Summary of Work Performed**—

Intertidal monitoring

Field work for monitoring intertidal communities in Kachemak Bay was conducted between 4-9 May and 3-6 June 2012. Monitoring was done at five rocky intertidal sites and four seagrass sites. Rocky sites were in Port Graham, Outside Beach, Cohen Island, Bishop's Beach and Bluff Point. Seagrass sites were in Jakalof Bay, Herring Island, Peterson Bay and Homer Spit. Briefly, rocky intertidal sampling included quantitative assessment of the rocky intertidal community at the high, mid, low and -1 m tidal elevations using percent cover estimates and counts. At these sites, a minimum of 100 *Tectura persona* were measured for shell length at each rocky site to establish size-frequency distribution. A temperature data logger (HOBO, Onset Computers) was deployed at the low stratum at each rocky intertidal site. In addition, mussel beds in the vicinity of three of the rocky intertidal sites (Port Graham, Outside Beach and Cohen Island) were monitored for mussel abundance and size-frequency distribution. Seagrass beds were monitored by counting *Zostera marina* shoot density and estimating percent cover of biota and sediments, and, where possible (all except Homer Spit), the extent of the bed was estimated from width measurements.

Scat collection and foraging observations

During this reporting period, we continued data collection at our long-term site in Little Tutka Bay during the winter months. We collected 24 sea otter scat samples between December 2nd 2011 and March 2nd 2012, which were then processed this reporting period. We sorted each scat sample by prey type and assigned a percentage frequency method using a 1 – 6 ranking (1 = 1 – 5%; 2 = 5 – 25%; 3 = 25 – 50%; 4 = 50 – 75%; 5 = 75 – 95%; 6 = 95 – 100%). During this and the previous collection period, 15 samples were from calendar year 2011 and all remaining samples (n=39) were from 2012. To summarize the categorical data on diet from scat samples, the median value for each category was used and then averaged by the monthly collection period. Scat sample collection continues at this time and samples are stored in the KBRR lab freezer.

Focal animal sampling was used to select study animals and all visual foraging observations were conducted with a high-power telescope (Questar field model 50x). Methods followed previously established protocols for visually identifying prey and estimating prey size.

Preliminary results of intertidal monitoring

We presented first results of this work in a poster at the 2013 Alaska Marine Science Symposium. The poster was entitled “*Long-term monitoring of coastal rocky beaches in Kachemak Bay*”. Intertidal communities in Kachemak Bay were significantly different at sites along the south shore of the bay from sites along the north shore (Figure 1). These differences were most obvious at the low at -1 m strata. North shore rocky sites had lower species richness than sites at the south shore.

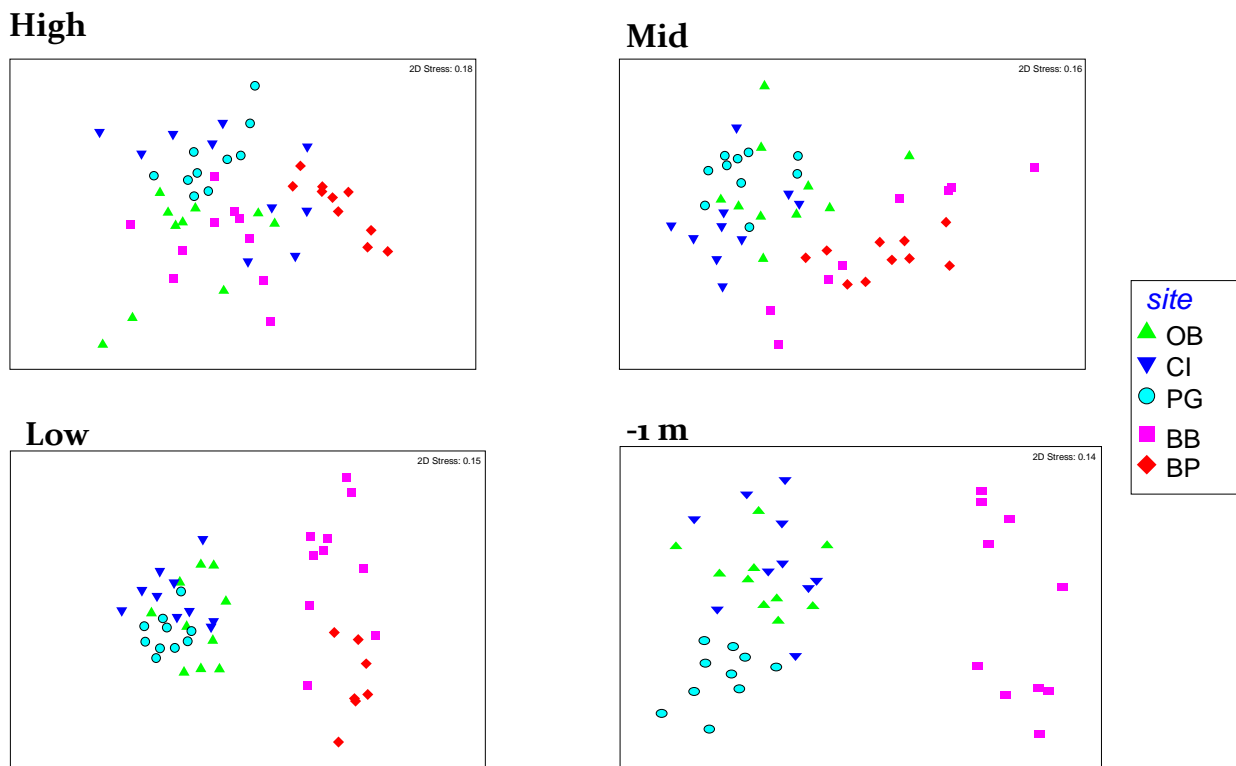

Figure 1. MDS plots of intertidal community structure by stratum for 5 rocky intertidal sites in Kachemak Bay. Outside Berach (OB), Cohen Island (CI) and Port Graham (PG) are on the south side of the bay and Bishop's Beach (BB) and Bluff Point (BP) are on the north shore

Mussel abundance was highly variable within and among sites (Figure 2). Common to all three sites was a high frequency of small mussels (<5 mm) and very few individuals > 25 mm. The largest individual found was at Outside Beach and was 35 mm long. Seagrass beds had an average shoot density of approximately 50 shoots 0.25 m^{-2} , except for the Herring Island bed, which had a high density of an average of 120 shoots 0.25 m^{-2} .

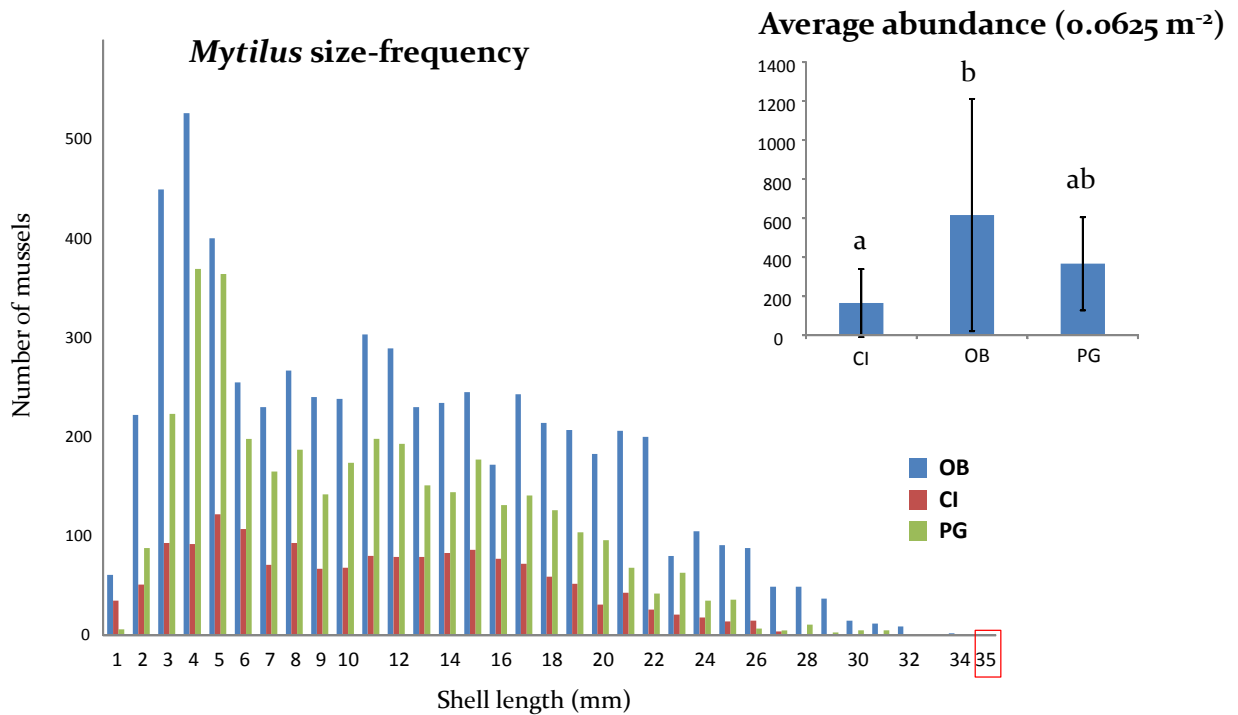

Figure 2. Average abundance and size-frequency distribution of mussels at three rocky intertidal sites in Kachemak Bay. See Figure 1 for site definitions.

Preliminary results of scat analysis and foraging observations

Within a scat sample, the maximum number of prey identified was 6 and the minimum was 1 (sample sizes for sea otters n=23; for *Lontra canadensis* n=1). Cumulatively (years 2008 to 2012), major prey types in the sea otter diet were crab, mussel, urchin, and clam (Figure 3). In recent years, clams and urchins were more common than in former years, when diet was dominated by crab and mussels. From the scat samples collected in 2011 to 2012, the major prey types were again mussel, crab, urchin, and clam (Figure 4). The main crab species we identified in sea otter scat in 2011-2012 were helmet crab (*Telmessus cheiragonus*) and red rock crab (*Cancer oregonensis*); however, a new crab species was identified in samples from this year, the hairy crab (*Hapalogaster mertensii*).

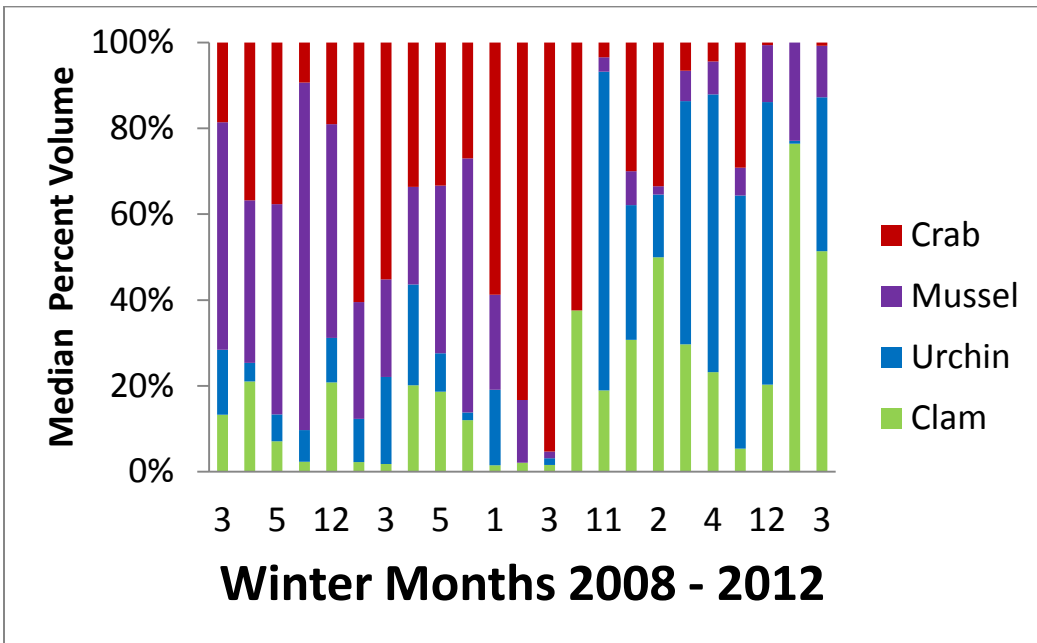

Figure 3. Volume of prey types in sea otter scats in the winter months (2008 to 2012).

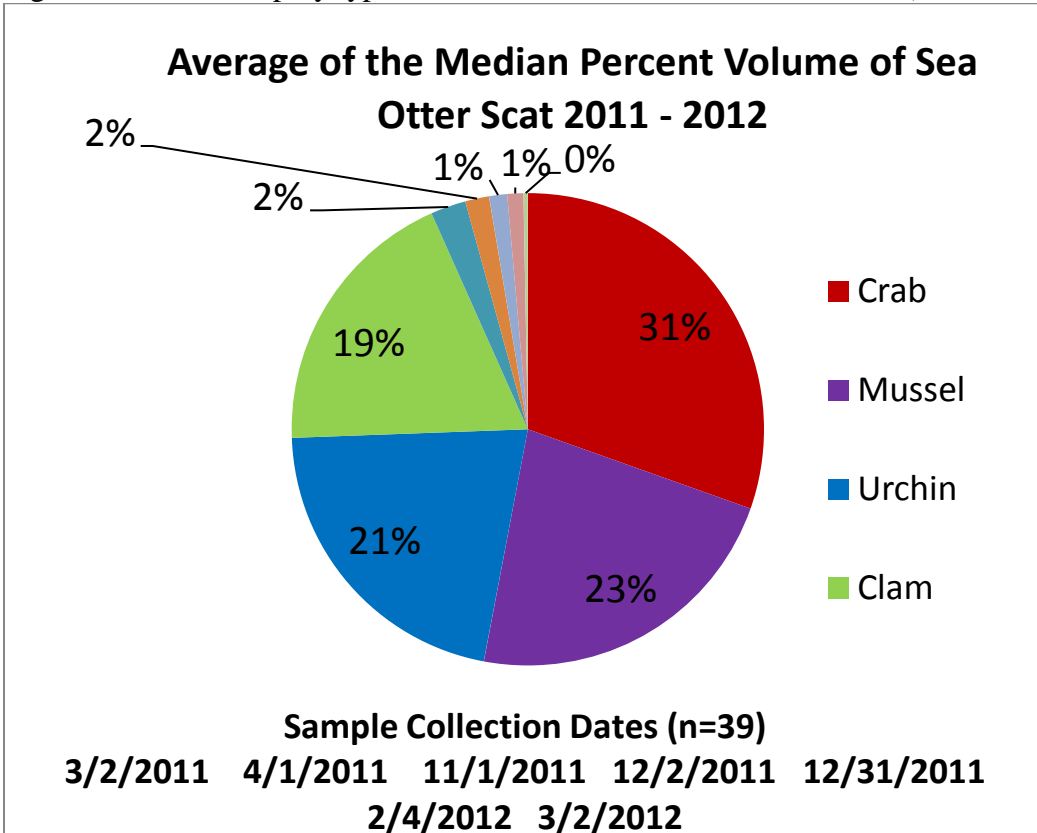

Figure 4. Average volume of prey types found in sea otter scats (2011 to 2012).

During our monitoring period, we observed four foraging sea otters on October 19th, 25th, and 26th 2012. Visual observations of prey types consisted of 59% unknown, 14% unknown clam, 3% unknown bivalve and 3% green urchin. The number of successful dives was 75% or 27 successful dives out of 37. The mean prey number per dive was 1.6. From the north side of Kachemak Bay, visual observations were difficult to obtain and focal animals were often too far from shore to determine prey species.

Overall, the project met its objectives. Some details in the sampling protocol were adjusted in the field based on practicality or local situation, but in ways that did not jeopardize the objectives. Sampling protocols, pictures and field data have been submitted to the Ocean Workspace database.

h) Summary of Future Work to be Performed—

Intertidal monitoring including the same measures as described above will be performed between 7-13 May 2013. An additional assessment in 2013 will include clam density in soft-sediment environments. Locations will be determined in the field but may include several sites for which historical clam data exist.

i) Coordination/ Collaboration—

Intertidal work was coordinated with the USGS Benthic Monitoring Group monitoring intertidal communities in Prince William Sound to ensure comparability of resulting data. We will also be meeting with this group in March to coordinate database structures for the visual observation data on sea otter foraging. We also collected particulate organic matter from the water column as well as macroalgal and invertebrate tissues for Dr. Seth Newsome for stable isotope analysis to investigate the intertidal food web. We also collected mussels for contaminant studies.

j) Community Involvement/ TEK and Resource Management Application—

The sea otter scat collection is done through citizen science collaboration with the land/dock owners and the regularly scheduled mail delivery run in the area. Scat analysis as well as foraging field observation and data recording is done with the involvement of UAA Kachemak Campus students. We will continue to work with new observers until there is a pattern of agreement on prey type, size, and number to ensure consistency among results.

k) Information Transfer—

No publications were produced during the reporting period. A poster presentation was given at the Alaska Marine Science Symposium in Anchorage in January 2013 entitled “*Long-term monitoring of coastal rocky beaches in Kachemak Bay*”. Data files and metadata for the intertidal monitoring were submitted to the Ocean Workspace database.

I) Budget—

The following provides a current status of the budget for this portion of the project. There have been no major changes in the budget.

**EXXON VALDEZ OIL SPILL TRUSTEE COUNCIL
ANNUAL PROGRAM REPORT YEAR 1**

Budget Category:	Proposed Year 1	Actual Year 1	TOTAL Difference
Personnel	\$20,000	\$4,732	\$15,268
Travel	\$1,000	\$407	\$593
Contractual	\$6,400	\$0	\$6,400
Commodities	\$2,100	\$68	\$2,032
Equipment	\$0	\$0	\$0
Other	\$0	\$0	\$0
Indirect Costs (<i>will vary by proposer</i>)	\$14,600	\$2,577	\$12,023
SUBTOTAL	\$44,100	\$0	\$36,316
General Administration (9% of subtotal)	\$3,969	\$0	\$3,268
PROJECT TOTAL	\$48,069	\$0	\$39,584
Other Resources (Cost Share Funds)	\$0	\$0	\$0

COMMENTS: Invoices received to PWSSC through period ending 12/31/2012, Last Invoice received for period ending 09/30/12

FY12

**Program Title: 12120114-L, Ecological
Communities in Kachemak Bay
Team Leader: Konar**

SUMMARY

- a) **Project Number**— 12120114-R
- b) **Project Title**—Nearshore Benthic Systems in the Gulf of Alaska
- c) **Principal Investigator**— B. Ballachey, J. Bodkin, H. Coletti, T. Dean, D. Monson; Co-PI's: K. Kloecker, M. Lindeberg, B. Weitzmann, A. Doroff, M. Shephard, B. Konar, K. Iken
- d) **Time Period Covered by the Report**—02/01/12 to 01/31/13
- e) **Date of Report**— 03/01/13
- f) **Project Website**— N/A
- g) **Summary of Work Performed**—

Our fieldwork for year 1 (2012 field season) has been completed with no problems or concerns. We conducted 7 field trips between March and late July, including 2 to Katmai National Park, 1 to Kenai Fjords National Park, 2 to western PWS, and 2 to eastern PWS. At Katmai, Kenai Fjords and WPWS, we visited sites that were established in previous years, and in EPWS, we established new sampling sites. We also did preliminary work at two sites in northern PWS to be sampled in summer 2013 (and we will establish 3 more sites in NPWS at that time). Work completed in all areas included monitoring of rocky intertidal, soft sediment and mussel sites, eelgrass beds, and black oystercatcher nests, as well as collection of sea otter forage data. We also completed a winter bird survey at Katmai, summer bird surveys in Katmai and Kenai Fjords, sea otter carcass collections in WPWS, Katmai and Kenai Fjords, and aerial surveys of sea otters at Katmai and in WPWS. We have continued to coordinate our monitoring efforts with the intertidal work being done in Kachemak Bay (K. Iken and B. Konar), and we completed an aerial survey of sea otters in Kachemak Bay in August. Mussels were sampled at 9 locations in PWS and 2 locations in Kachemak Bay, and submitted to NOAA for contaminant analyses as part of their Mussel Watch program. A report entitled "*Intertidal Invertebrate and Algae Monitoring: Power to Detect Temporal Trends*" was submitted to NPS by WEST, Inc. and is in review; we anticipate further work on these statistical analyses with WEST in year 2013 (funding for this component provided by NPS). We expanded collections of nearshore species for stable isotope analyses (we initially planned to focus on mussels) to establish priorities for future stable isotope sampling, and sampled a broad suite of nearshore species in all locations. Analyses of stable isotopes (carbon and nitrogen) in these samples are underway in the laboratory of Dr. S. Newsome. In addition, we are developing assays to evaluate gene expression and physiological status of mussels, as a tool for monitoring long-term health of the nearshore, in collaboration with Drs. L. Bowen and K. Miles (USGS-WERC) and T. Hollmen (AK SeaLife Center).

h) **Summary of Future Work to be Performed**—

We anticipate no changes to the work plan we initially submitted for the nearshore benthic component. For the upcoming field season, we will sample nearshore sites in all areas in June and July, as projected, and conduct surveys (marine birds, sea otters, and sea otter carcasses) in March, April, June and July.

i) **Coordination/Collaboration**—

Coordination and collaboration of our work with other components of the project are proceeding with no concerns. We have established collaborations with Dr. Seth Newsome (University of New Mexico) for a study of the nearshore food web based on stable isotopes; with Drs. Liz Bowen and Keith Miles at USGS Western Ecological Research Center and Dr. Tuula Hollmen at the Alaska SeaLife Center to study gene expression and physiological biomarkers of mussels.

j) Community Involvement/ TEK and Resources Management Applications—

A project proposal has been submitted by USGS and NPS to gather baseline information on juvenile salmon use of three nearshore habitat types (eelgrass, kelp and non-vegetated) along the coast of Katmai National Park and Preserve. This project will provide insight into fish diversity in these unique nearshore habitat types, which will shed light on the value of these habitats both within the nearshore and in relation to the ecological link between nearshore and terrestrial environments. These habitat types are currently being monitored by a collaborative effort between NPS Southwest Alaska Inventory & Monitoring Program, USGS and Gulf Watch Alaska Program. This information is of interest to park managers as potential oil and gas projects develop along Katmai's offshore waters. Also, at the request of managers at Kenai Fjords National Park, a second proposal is in preparation for enhanced efforts to monitor foraging habits of sea otters in the park, as recent observational data obtained by NPS-SWAN, USGS and the Gulf Watch Alaska program have demonstrated a relatively high reliance there on mussels, compared to sea otters foraging in other areas within the Gulf of Alaska. Additional understanding of the extent to which sea otters in Kenai Fjords prey on mussels, and potential vulnerability of otters to fluctuations in abundance of large mussels, is of interest to park managers.

k) Information Transfer—

- Publications produced during the reporting period:
 - The effects of spilled oil on coastal ecosystems: Lessons from the *Exxon Valdez* spill. Bodkin, J.L., D. Esler, S.D Rice' C.O. Matkin, and B.E. Ballachey. In press in: Julie L. Lockwood and Brooke Maslo, editors. Coastal Conservation. Cambridge University Press Series in Conservation Biology.
- Conference and workshop presentations and attendance during the reporting period:
 - November 2012 PI meeting: attended by Ballachey, Bodkin, Coletti, Dean, Doroff, Iken, Kloecker, Monson, Shephard, Weitzmann.
 - January 2013 AK Marine Science Symposium: attended by Ballachey, Coletti, Doroff, Kloecker, Konar, Lindeberg, Monson, Shephard, Weitzmann.
- Posters presented at 2013 AMSS:
 - Katrina L. Counihan-Edgar, Tuula Hollmen, and Heather Coletti. Physiological assessment of *Mytilus* spp. in Kenai Fjords National Park.
 - Brooke Carney, David Tessler, Heather Coletti, and Douglas Causey. Long-term diets of Black Oystercatchers (*Haematopus bachmani*), evidence from stable isotopes - preliminary results.
 - Alan J. Mearns, Kate McLaughlin, Rob Campbell, James Bodkin, Thomas Dean, Brenda Ballachey and John Harper. *Joint effort adds 24th year to long-term rocky intertidal photo-monitoring of western Prince William Sound.*
 - Heather Coletti, James L. Bodkin, Brenda E. Ballachey, Thomas A. Dean, Katrin Iken, Kimberly A. Kloecker, Brenda Konar, Mandy Lindeberg, and Daniel Monson. *Monitoring nearshore marine ecosystems in the Gulf of Alaska: Detecting change and understanding cause.*
- Data and/or information products developed during the reporting period:

Multiple data sets are collected in each of our study areas annually. We are currently in the process of adding metadata to the various data sets for placement on the AOOS workspace.

I) Budget—

EXXON VALDEZ OIL SPILL TRUSTEE COUNCIL
ANNUAL PROGRAM REPORT YEAR 1

Budget Category:	Revised Year 1	Actual Year 1	TOTAL Difference
Personnel	\$117,000	\$60,315	\$56,685
Travel	\$1,500	\$3,254	(\$1,754)
Contractual	\$113,125	\$66,857	\$46,268
Commodities	\$5,500	\$6,648	(\$1,148)
Equipment	\$22,000	\$11,715	\$10,285
Other	\$0	\$0	\$0
Indirect Costs (will vary by proposer)	\$0	\$0	\$0
SUBTOTAL	\$259,125	\$148,789	\$110,336
General Administration (9% of subtotal)	\$23,300	\$23,300	\$0
PROJECT TOTAL	\$282,425	\$172,089	\$110,336
Other Resources (Cost Share Funds)	\$25,000	\$0	\$25,000

COMMENTS:

FY12

Program Title: 12120114-R, Nearshore benthic systems in the Gulf of Alaska
Team Leader: Ballachey & Dean
Agency: USGS/ CRA, Inc

SUMMARY

- a) **Project Number—** 12120114-G
- b) **Project Title—**Long-term monitoring of oceanographic conditions in Cook Inlet/Kachemak Bay to understand recovery and restoration of injured near-shore species
- c) **Principal Investigator—** Angela Doroff (Kachemak Bay National Estuarine Research Reserve), Kris Holderied (NOAA Kasitsna Bay Laboratory)
- d) **Time Period Covered by the Report—**02/01/12 to 01/31/13
- e) **Date of Report—** 02/15/13
- f) **Project Website—** N/A
- g) **Summary of Work Performed—**

Oceanographic and Plankton Surveys

Our survey areas are located in lower Cook Inlet (Transects 3, 6, and 7) and in Kachemak Bay (Transects 4 and 9), (Fig. 1). Monthly Kachemak Bay oceanographic and plankton surveys were conducted along Transect 9 from February through October 2012 and in January 2013. Surveys could not be conducted in November and December, 2012 due to adverse weather conditions and ice in the Homer harbor which prevented safe small boat operations. Three lower Cook Inlet seasonal surveys were conducted along Transects 3, 4, 6, and 7 during 2-3 May, 29-31 July, and 28-29 October. In addition to these planned surveys, we leveraged help from NOAA Hollings undergraduate summer interns at Kasitsna Bay lab and additional funding

from the NOAA Integrated Ocean Observing Program to make additional measurements and assess tidal and spatial variability of marine conditions in Kachemak Bay. During 31 May and 5 June, we used two vessels to collect samples during high and low tides, concurrently along transects 9 and 4 (mid and outer Kachemak Bay). On 25 June and 2 July we collected oceanography data in the Kachemak Bay sub-bays. On 15 August we again used two boats to conduct a comprehensive spatial survey of Kachemak Bay, including Transects 4 and 9, an along-bay transect and the sub-bays. Finally, on 21 September we conducted a 12-hour time series survey along Transect 9. Collectively, nearly 350 conductivity-temperature-depth (CTD) profiles were made in the first project year.

Oceanographic profile data are available in Seabird Electronics data format for all surveys, with ongoing conversion to Excel spreadsheets and graphs of salinity/conductivity profiles. In November, we began to compile the historical CTD data for the study area and are preparing data formats for uploading into the Gulf Watch data portal. We are providing temperature and salinity profile data to the National Ocean Service (NOS) Coast Survey Development Laboratory for validation of the new Cook Inlet ocean circulation model. This model is being used by NOS to produce a tidal energy assessment of Cook Inlet, in partnership with the Alaska Energy Authority.

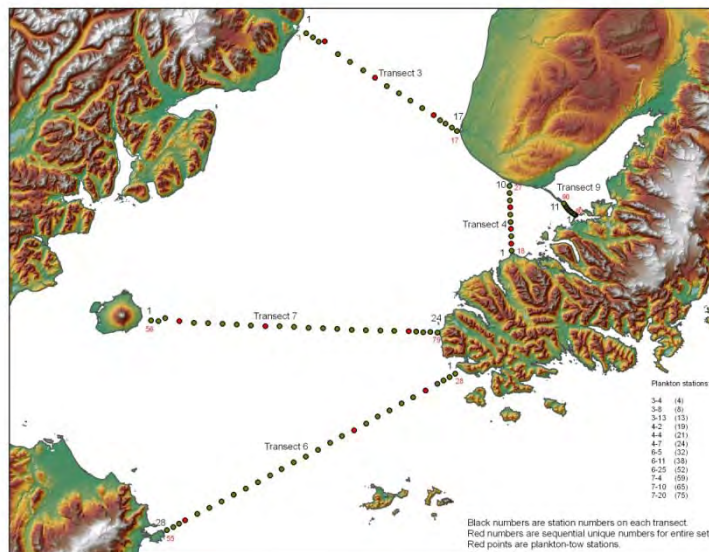

Figure 1. Study area in Kachemak Bay and lower Cook Inlet, Alaska showing sampling station locations. Each red station is a location where phytoplankton, zooplankton, and water samples are collected.

Water Quality Monitoring

Continuous data collection and reporting continued throughout the reporting period for the KBNERR System-wide Monitoring Program for meteorological, water quality, and monthly nutrient samples; all data are being quality controlled and archived through the NERR's Central Data Management Office. In this reporting period, we purchased a YSI moored buoy system and deployed a data sonde to monitor water quality in Bear Cove; the system was up and running by mid July 2012 and was removed at the end of September 2012 for the winter. The system was telemetered to provide researchers and local oyster farmers would have access to the water quality data in real-time mode. We are working with AOOS to get the

information on the web. In addition to establishing a new water quality monitoring site, we upgraded our KBNERR System-Wide Monitoring Program (SWMP) system with four new sondes which have an optical port for continuous monitoring of chlorophyll-a (chl-a); this allows for monitoring all three surface stations for chl-a throughout the summer months.

Zooplankton Sampling

Beginning in April 2012, monthly zooplankton tows (with the exception of Nov and Dec 2012) were conducted at three stations along Transect #9 throughout the reporting period. Samples were also collected during the hydrographic surveys at 3 stations per transect (see Fig 1.). Samples from April and May have been analyzed by the Prince William Sound Science Center (PWSSC); all remaining samples will be sent to PWSSC for analysis in the next reporting period. We continue coordinating methods with PWSSC.

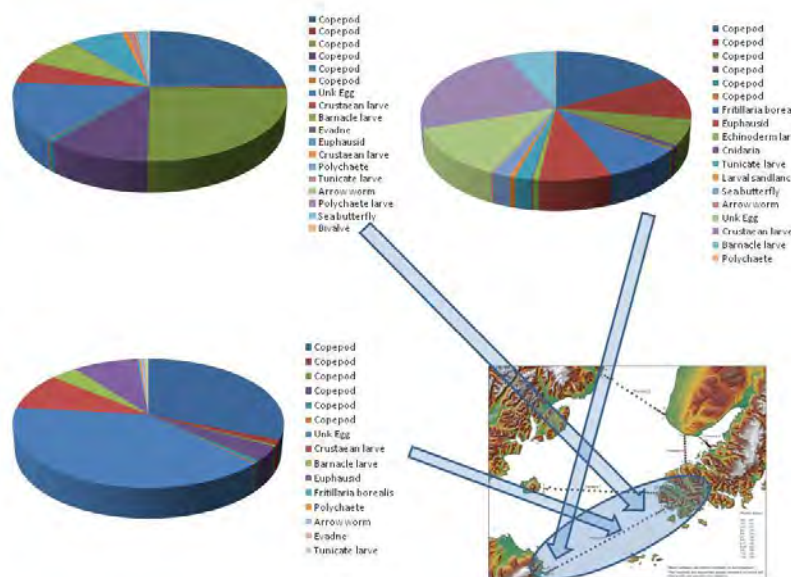

Figure 2. This is an illustration of the types and relative abundance of zooplankton encountered along transect #6 during 3-4 May 2012 using bongo-style plankton nets in lower Cook Inlet, Alaska.

Phytoplankton Sampling

We supplemented an ongoing Kasitsna Bay Laboratory phytoplankton monitoring program during our oceanographic surveys, with a focus on the algal species that cause paralytic shellfish poisoning (*Alexandrium*) and juvenile fish kills in hatchery pens (*Chaetoceros*). Phytoplankton samples were collected at the laboratory dock, at three stations (near each end and in middle) along Transect #9 during the monthly oceanography cruises, at three stations on each transect during the lower Cook Inlet surveys, and periodically during our supplemental oceanographic surveys. Samples were visually identified and enumerated using a light microscope and volumetric Palmer counting cells at Kasitsna Bay Laboratory. A subset of the samples was also analyzed at our sister NOAA laboratory in Beaufort NC, using the more sensitive molecular technique of quantitative specific quantitative polymerase chain reaction assay (qPCR). Plankton concentrations increased from low or undetectable levels during winter and early spring to their highest concentrations in late June before declining in August. *Alexandrium fundyense* cells were found at all Kachemak Bay sampling

locations throughout the summer, although at relatively low concentrations. *A. fundyense* concentrations were found to be significantly correlated with both water temperature and salinity conditions. Chaetoceros spp. were the most numerous species, peaking at over 1,400,000 cells/liter in late June.

h) Summary of Future Work to be Performed—

We attempted to conduct a lower Cook Inlet oceanography survey during in mid-February 2013, but due to adverse sea state conditions in the Inlet we were only able to make measurements in Kachemak Bay along Transects 4 and 9. However, we did add an along-bay survey to assess the impact of freshwater input from the significant winter rainfall this year on bay waters. During the next year of the study, monthly small boat surveys of oceanography, zooplankton and phytoplankton will be conducted in Kachemak Bay (Transect 9). The larger survey in outer Kachemak Bay and lower Cook Inlet (Transects 3, 4, 6 and 7) will be conducted four times, with planned dates of April (19-22), July (17-21), October (25-29), and February 2014. Year-round water quality monitoring will continue as part of the KBNERR SWMP program at the Homer and Seldovia harbors. The additional water quality station and nutrient monitoring in Bear Cove is planned to begin in March 2013 and continue into the fall until the onset of freezing conditions.

We are in the process of documenting metadata for data collected as part of this study as well as the some of the historical hydrographic data. We are developing an Access data structure to link data on oceanography, plankton, water chemistry, birds, and mammals collected in this study. Database management and analyses of oceanography, phytoplankton, and zooplankton data are ongoing efforts.

i) Coordination/ Collaboration—

Zooplankton analyses are being done in collaboration with Rob Campbell at the PWSSC (funded on another Gulf Watch Alaska project). During all outer Kachemak Bay and lower Cook Inlet surveys, we were able to collect water samples to support an ocean acidification sampling program done by Kasitsna Bay Laboratory in collaboration with the Alaska Ocean Observing System (AOOS) and University of Alaska Fairbanks. We hosted U.S. Fish and Wildlife Service staff (L. Labunski) from the At Sea Observer Program, who collected information on bird and mammal distributions during the May and October Cook Inlet surveys. Examples of seabird observations on puffins and murrelets are provided in Figure 3.

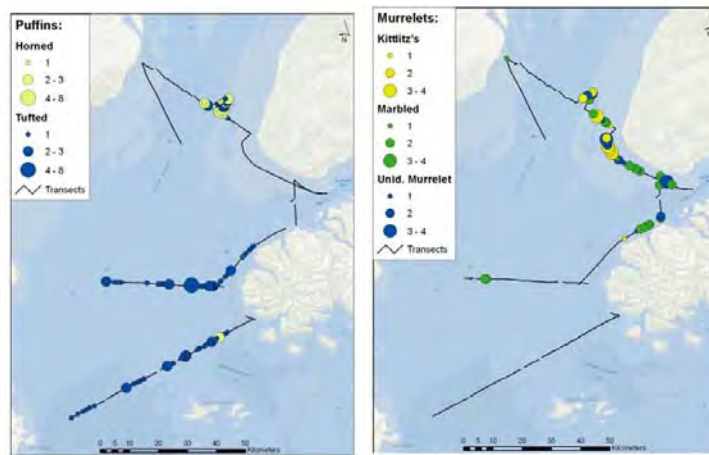

U.S. Fish and Wildlife Service, Migratory Bird Management At Sea Observer Program.
Maps provided by L. Labunski and K. Kuletz

Figure 3. Observed distribution of seabirds (puffins on left and murrelets on right) during July 2012 lower Cook Inlet oceanography survey. Observations made by USFWS At Sea Observer Program staff.

j) Community Involvement/ TEK and Resource Management Application—

We were able to leverage funding from this study with a KBNERR State Wildlife Grant to obtain better Chlorophyll-a monitoring during the summer months when a KBNERR-supported community monitoring program is collecting data on harmful algal blooms; these data help observers and local oyster farmers interpret oceanographic conditions relative to phytoplankton blooms. We also leveraged support for sample collection of water samples to interpret ocean acidification patterns in the region which is of great concern for local oyster farmers.

k) Information Transfer—

No publications were produced during the reporting period.

Presentations on this project were made to the Kachemak Bay Research Reserve’s Community Council, the AOOS Cook Inlet Modeling Group and two poster presentations were made at the 2013 Alaska Marine Science Symposium (see titles and authors below). Public presentations using project data were also made by two NOAA Holling Scholar students at the KBNERR Brown Bag Seminar Series in Homer.

AK Marine Science Symposium. 2013. Poster presentation. Effect of environmental conditions on toxic *Alexandrium fundyense* abundance in Kachemak Bay, AK. Charlayna Cammarata, Rebecca Hollmann, Mark Vandersea, Dominic Hondoloro, Kristine Holderied, Wayne Litaker

AK Marine Science Symposium. 2013. Poster presentation. Seasonal variability in phytoplankton and oceanography in Kachemak Bay, Alaska. Dominic Hondoloro, Charlayna Cammarata, Rebecca Hollmann, Kristine Holderied

I) Budget—

**EXXON VALDEZ OIL SPILL TRUSTEE COUNCIL
ANNUAL PROGRAM REPORT YEAR 1**

Budget Category:	Proposed Year 1	Actual Year 1	TOTAL Difference
Personnel	\$0	\$0	\$0
Travel	\$4,200	\$2,417	\$1,783
Contractual	\$3,000	\$0	\$3,000
Commodities	\$13,000	\$0	\$13,000
Equipment	\$5,000	\$0	\$5,000
Indirect Costs (<i>will vary by proposer</i>)			\$0
SUBTOTAL	\$25,200.0	\$2,417.0	\$22,783.0
General Administration (9% of subtotal)	\$2,268.0	\$0.0	\$2,268.0
PROJECT TOTAL	\$27,468.0	\$2,417.0	\$25,051.0
Other Resources (Cost Share Funds)	\$0	\$0	\$0

COMMENTS: Project was able to leverage existing NOAA equipment (including calibrated CTD) and boat fuel for federal FY12 and then carryover of funds to FY13 was delayed. Therefore execution of project year 1 equipment and boat fuel purchases and administrative costs have been delayed to project year 2 (but will be accomplished in federal FY13). In-kind contributions: 1. Salary for Holderied and Kasitsna Bay Lab staff (\$25K). 2. Use of conductivity-temperature-depth profiler (\$5K) 3. Use of KBL small boats for surveys (\$3K).

FY12

**Program Title: Long-term monitoring of oceanographic conditions in Cook Inlet/ Kachemak Bay
Team Leader: Kristine Holderied (NOAA)**

SUMMARY

**EXXON VALDEZ OIL SPILL TRUSTEE COUNCIL
ANNUAL PROGRAM REPORT YEAR 1**

Budget Category:	Proposed Year 1	Actual Year 1	TOTAL Difference
Personnel	\$66,000	\$45,452	\$20,548
Travel	3,700	\$568	\$3,132
Contractual	\$49,800	\$38,360	\$11,440
Commodities	\$8,100	\$6,675	\$1,425
Equipment	\$23,800	\$12,000	\$11,800
Indirect Costs (<i>will vary by proposer</i>)			\$0
SUBTOTAL	\$151,400	\$103,054	\$48,346
General Administration (9% of subtotal)	\$13,626	\$9,275	\$4,351
PROJECT TOTAL	\$165,026	\$112,329	\$52,697
Other Resources (Cost Share Funds)	\$120	\$222	\$0

COMMENTS: Personal: We were under spent in this category due to changes in personnel at the KBNERR; To help integrate our project with the benthic monitoring work, these funds will be used for the PI to participate in upcoming field work for the benthic monitoring projects in FY13/14.
 Contractual: the budget reflected ship time for four hydrographic surveys of in lower Cook Inlet; we conducted only three during this reporting period. We completed the fourth survey in February which we anticipate will put us approximately \$1.5K over budget in this category.
 Equipment: we leveraged our LTM grant to obtain \$102K for new water quality monitoring equipment; \$12K from this grant was leveraged as match for the grant. The remaining funds in this budget will be used to purchase replacement probes for water quality monitoring and to maintain and calibrate CTD instruments.
 Other Resources: we leveraged \$120K from our SWMP. The total of leveraged funds in this reporting period was \$222K.

FY12

**Program Title: 121120114-G, LTM-ED
lower Cook Inlet & KBay
Team Leader: A. M. Doroff**

SUMMARY

**EXXON VALDEZ OIL SPILL TRUSTEE COUNCIL
ANNUAL PROGRAM REPORT YEAR 1**

Budget Category:	Proposed Year 1	Actual Year 1	TOTAL Difference
Personnel	\$66,000	\$45,452	\$20,548
Travel	\$7,800	\$2,985	\$4,815
Contractual	\$52,300	\$38,360	\$13,940
Commodities	\$21,100	\$6,675	\$14,425
Equipment	\$28,800	\$12,000	\$16,800
Other	\$0	\$0	\$0
Indirect Costs (<i>will vary by proposer</i>)	\$0	\$0	\$0
SUBTOTAL	\$176,000	\$105,471	\$70,529
General Administration (9% of subtotal)	\$15,840	\$9,275	\$6,565
PROJECT TOTAL	\$191,840	\$114,746	\$77,094
Other Resources (Cost Share Funds)	\$120	\$222	(\$102)

COMMENTS: See Doroff and Holderied Tab to review Actual expenditure notes.

FY12

**Program Title: 12120114-G, LTM-Lower Cook Inlet
Team Leader: Doroff and Holderied**

SUMMARY

- a) **Project Number—** 12120114-E
- b) **Project Title—**Long-Term Monitoring of Oceanographic Conditions in Prince William Sound
- c) **Principal Investigator—** Robert W. Campbell
- d) **Time Period Covered by the Report—**02/01/13 to 01/31/13
- e) **Date of Report—** 09/15/13
- f) **Project Website—** N/A
- g) **Summary of Work Performed—**

The first year of this project was given over to equipment acquisition and testing, and field operations were covered under the ongoing Herring Survey project (EVOS Project 10100132A). The Autonomous Moored Profiler (AMP) arrived in August of 2012. The delivery of the profiler was considerably behind schedule as the manufacturer had significant problems integrating the telemetry hardware for transmitting data out from the profiler in real-time. The profiler was tested in Nelson Bay in September 2012, and performed flawlessly. It was decided that it would not be prudent to make its first operational deployment in central PWS during winter, because servicing visits might be hampered by weather if they were required. The mooring will be deployed prior to the 2013 spring bloom, in March or April. Beyond the scheduling changes, no changes have been made to the original project objectives. Ship-based surveys of hydrography, nutrients and plankton will continue in March or April, as

planned.

The Agilent 7100 Capillary Electrophoresis instrument (for nutrient analysis) was also purchased in 2012, and underwent preliminary testing and protocol development from August to December 2012. There were several significant setbacks, including a serious hardware failure (repaired under warranty). The system is currently operational, and method development is ongoing into the first quarter of 2013.

h) Summary of Future Work to be Performed—

Key milestones and objectives in the coming year include the following:

FFY 13, 2nd quarter (January 1, 2013-March 31, 2013)

March: Vessel survey/deploy mooring if weather allows

FFY 13, 3rd quarter (April 1, 2013-June 30, 2013)

April: Vessel survey/deploy mooring /sample processing ongoing

May: Vessel survey/sample processing ongoing

June: Vessel survey/service mooring/sample processing ongoing

FFY 13, 4th quarter (July 1, 2013-September 30, 2013)

July-September: Mooring operational, sample processing ongoing

July: Vessel survey/service mooring

August: Vessel survey

FFY 14, 1st quarter (October 1, 2014-December 31, 2014)

October-December: Mooring operational, sample processing ongoing

October: Vessel survey/service mooring

i) Coordination and Collaboration—

Zooplankton samples from the Lower Cook Inlet component were received in June 2012, all have been processed and counted, and the data sent back to Angela Doroff. Another set of samples is expected in February 2013.

j) Community Involvement/TEK and Resource Management Applications—

A community lecture outlining this project (entitled “Recent trends in PWS Oceanography”) was delivered by Campbell on December 4th, 2012.

k) Information Transfer—

Campbell, R.W. 2013. State of the Sound: Trends in the oceanography of Prince William Sound. Poster at Alaska Marine Science Symposium, January 2013.

I) Budget—

No changes have been made to the budget.

**EXXON VALDEZ OIL SPILL TRUSTEE COUNCIL
ANNUAL PROGRAM REPORT YEAR 1**

Budget Category:	Proposed Year 1	Actual Year 1	TOTAL Difference
Personnel	\$12,400	\$0	\$12,400
Travel	\$0	\$0	\$0
Contractual	\$1,000	\$1,295	(\$295)
Commodities	\$0	\$5,261	(\$5,261)
Equipment	\$205,000	\$209,105	(\$4,105)
Other	\$0	\$0	\$0
Indirect Costs (<i>will vary by proposer</i>)	\$0	\$0	\$0
SUBTOTAL	\$218,400	\$215,661	\$2,739
General Administration (9% of subtotal)	\$19,656	\$19,409	\$247
PROJECT TOTAL	\$238,056	\$235,070	\$2,986
Other Resources (Cost Share Funds)	\$0	\$0	\$0

COMMENTS: Invoices received to PWSSC through period ending 1/31/13

FY12

**Program Title: 12120114-E,
Oceanographic Conditions in PWS
Team Leader: Campbell**

SUMMARY

- a) **Project Number**—12120114-A
- b) **Project Title**— Continuous Plankton Recorder Sampling
- c) **Principal Investigator’s Name(s)**— Sonia Batten
- d) **Time Period Covered by the Report**— 01/02/12 to 31/01/13
- e) **Date of Report**—01/03/13
- f) **Project Website**—<http://pices.int/projects/tcprstnp/default.aspx>, www.sahfos.org
- g) **Summary of Work Performed**—

Note that in FY 2012 funding was provided under EVOS project 10100624, not the Gulf Watch Alaska project.

Deliverable	Status
April 2012 <ul style="list-style-type: none"> • First north-south transect 	<ul style="list-style-type: none"> • Sampled 7th-9th April. Sample processing complete
May 2012 <ul style="list-style-type: none"> • Second north-south transect 	<ul style="list-style-type: none"> • Sampled 10th-12th May. Sample processing complete
June 2012 <ul style="list-style-type: none"> • Fourth north-south transect 	<ul style="list-style-type: none"> • Sampled 9th-11th June. Sample processing complete
July 2012 <ul style="list-style-type: none"> • Fourth north-south transect 	<ul style="list-style-type: none"> • Sampled 12th-14th July. Preliminary samples processed.
August 2012 <ul style="list-style-type: none"> • Fifth north-south transect 	<ul style="list-style-type: none"> • Towed 14th-15th August. CPR lost on August 15th. Eventually sampled again 13th-15th Sept. Preliminary samples processed
September 2012 <ul style="list-style-type: none"> • Sixth north-south transect 	<ul style="list-style-type: none"> • Towed 13th-16th October. Preliminary samples processed
October-November 2012 <ul style="list-style-type: none"> • Final tows unloaded and gear returned to SAHFOS for servicing 	<ul style="list-style-type: none"> • Gear was returned and serviced.
February 2013 <ul style="list-style-type: none"> • Set up for start of field season, ship equipment to west coast ports 	<ul style="list-style-type: none"> • Equipment is prepared and ready to be shipped.

Sampling during the second half of the year did not go as

smoothly as the first. On August 15th, the crew of the *Horizon Kodiak* towing the north-south transect pulled in the tow cable to change the second cassette to find the CPR no longer there. The cable was cleanly sheared which suggests an impact with a sizeable object, perhaps a

submerged shipping container, somewhere in the Gulf of Alaska. A second attempt was made to sample the transect, but a weld failed on the replacement tow body that was deployed in early September. This caused erratic towing, so the crew hauled in the CPR just a few miles into the transect. The body was repaired by the Kinnetic Laboratories team in Anchorage, and the transect was sampled again later that month – fortunately 3rd time lucky! The final sixth transect was sampled in October. All transects followed the usual route (Fig. 1).

At the time of writing this report, sample processing is complete until June and preliminary samples from July-October have been processed, the remainder will be completed soon and quality control will be undertaken. Data for 2012 in the figures below (Fig. 2) are therefore preliminary, and may change slightly once the final data are available.

Figure 1. Location of CPR samples collected on the shelf/slope. Samples south of PWS were collected 2000-2003, samples in Cook inlet and to the SE were collected 2004-2012. Note the consistency of this transect.

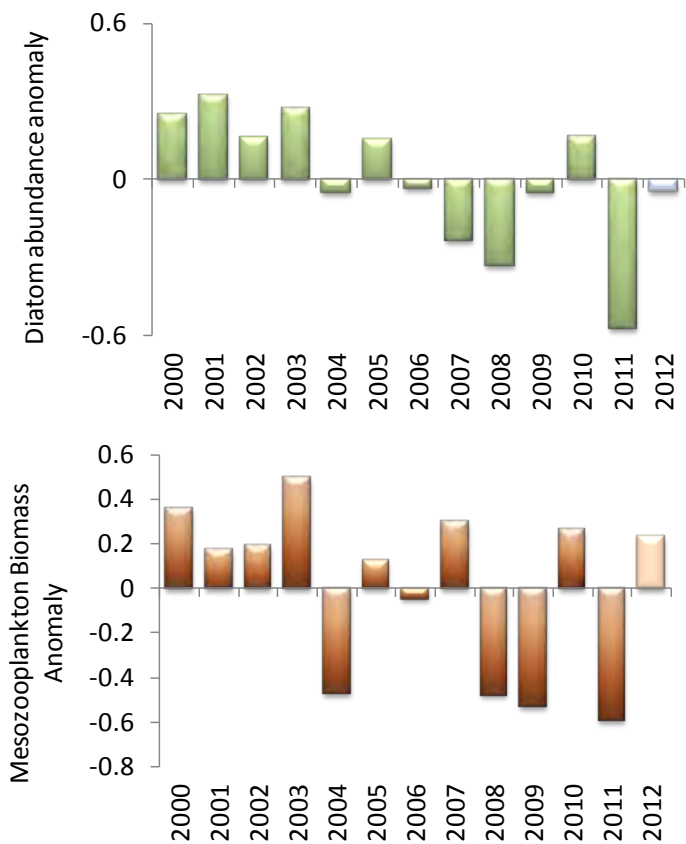

Figure 2. Derived data from the shelf samples shown in Fig. 1. Upper panel shows the annual diatom abundance anomaly and the lower panel the annual mesozooplankton biomass anomaly. 2012 data

The graphs in Figure 2 show that 2012 was a more normal year for plankton than was 2011. Diatom abundances were close to average, and mesozooplankton biomass above average. There is a positive, significant relationship between the two time series.

h) Summary of Future Work to be Performed—

There are no changes to the proposed schedule of work. Sampling is due to recommence in April 2013 and to run monthly thereafter until approximately September. 2012 sample analysis and QC will be complete by August 2013.

i) Coordination/ Collaboration—

Dr. Batten participated in project conference calls and the annual PI meeting in November 2012.

j) Community Involvement/ TEK and Resource Management Applications—

In January 2012 Dr. Batten visited the Horizon Kodiak and talked with the Captain and crew about the project. Many of the crew are from Alaska and have a keen interest in the marine environment.

k) Information Transfer—

- No publications were produced during the reporting period
- Conference and workshop presentations and attendance during the reporting period:
 - Dr. Batten gave an oral presentation entitled “*Ship of opportunity sampling of lower trophic levels*” at the 2012 PICES Annual Meeting, Hiroshima, Japan, October 2012 as well as a presentation to the PICES CPR Advisory Panel.
 - Dr. Batten gave an oral presentation entitled “*Fifty shades of green; phytoplankton time series from the CPR*” at the Alaska Marine Science Symposium, Anchorage, January 2013.
- data and/or information products developed during the reporting period:
 - Near surface temperature data were recorded on most transects. Taxonomically resolved phytoplankton and zooplankton sample abundances collected on each transect. From these, derived data such as total diatoms and mesozooplankton biomass are available.

- l) **Budget**—Funding was not provided under this contract for the 2012 FY. There are no proposed changes to the budget for 2013.

**EXXON VALDEZ OIL SPILL TRUSTEE COUNCIL
ANNUAL PROGRAM REPORT YEAR 1**

Budget Category:	Proposed Year 1	Actual Year 1	TOTAL Difference
Personnel	\$0	\$0	\$0
Travel	\$0	\$0	\$0
Contractual	\$0	\$0	\$0
Commodities	\$0	\$0	\$0
Equipment	\$0	\$0	\$0
Other	\$0	\$0	\$0
Indirect Costs (<i>will vary by proposer</i>)	\$0	\$0	\$0
SUBTOTAL	\$0	\$0	\$0
General Administration (9% of subtotal)	\$0	\$0	\$0
PROJECT TOTAL	\$0	\$0	\$0
Other Resources (Cost Share Funds)	\$0	\$0	\$0

COMMENTS: No funding for this project through LTM in Year 1, 2012. Invoices received to PWSSC through period ending 12/31/2012

FY12

**Program Title: 12120114-A,
Continuous Plankton Recorder (CPR)
Team Leader: Batten**

SUMMARY

- a) **Project Number**—12120114-P
- b) **Project Title**— Long-Term Monitoring of Oceanographic Conditions in the Alaska Coastal Current from Hydrographic Station GAK1
- c) **Principal Investigator's Name(s)**— Thomas Weingartner
- d) **Time Period Covered by the Report**— 01/02/12 to 31/01/13
- e) **Date of Report**—01/03/13
- f) **Project Website**—<http://www.ims.uaf.edu/gak1/>
- g) **Summary of Work Performed**—

We collected monthly CTD samples and recovered and re-deployed the GAK 1 mooring in March 2012. We are continuing to investigate the relationship between Seward sea level variability with respect to temperature/salinity changes at GAK 1 and the shelf wind field. We completed a peer-reviewed paper for the Journal of Geophysical Research in summer 2012, had it accepted in December 2012, and it is now in press. The salient results of this paper are that:

1. We quantified the different contributions to the oceanic heat budget within the Alaska Coastal Current (ACC) on the northern Gulf of Alaska shelf. We find that cross-shelf heat flux convergence is insignificant on annual average, but that the inner shelf heat budget appears entirely balanced by the (ACC), which re-supplies ~10-35% of the heat removed by air-sea fluxes during the cooling season. This result means that heat advection within the ACC is an important control on spring water temperatures.
2. We found that air-sea fluxes increase from east to west (over the Gulf of Alaska [GOA] shelf) and from off- to on-shore. The cross-shore gradients in heat flux are governed by wind speed gradients, likely due to ageostrophic near-shore wind events during the cooling season, while the along-shelf heat flux gradients are governed by the occurrence of low pressure systems in the northern GOA that result in cold northerly winds over the northwestern GOA.
3. These results underline the ACC's role as the dominant oceanic heat source to the northern GOA shelf, and further imply an increased cooling rate in the ACC in the region at the mouth of Cook Inlet/Kodiak Island/Shelikof Strait all west of GAK 1.

Our ultimate goal with respect to understanding sea level variability is to ascertain if this routinely measured variable can be used as a predictor of ACC transport. We know from previous work that the GAK 1 measurements provide an index of temperature and salinity variations in this current. If we can use sea level variability as an index for transport then sea level and GAK 1 data can be used as measures of ACC transports of heat, freshwater, and mass.

h) Summary of Future Work to be Performed –

We will recover and re-deploy the GAK 1 mooring in March 2013. The recovered instruments will be sent out for calibrations and these then applied to the data from those instruments. We will continue monthly CTD collections at station GAK1. We are continue our work on understanding the sources of variability in Seward sea level and if these can be related to transport variations in the ACC. We expect to complete this work by December 2013. There are no anticipated changes in the objectives.

i) Coordination/Collaboration –

Aside from participating in meetings with other EVOSTC funded colleagues, we continue to work with the Glacier Bay NPS team on combining our measurements with those obtained from Glacier Bay. We have also worked closely with EVOSTC LTM PI Russell Hopcroft on

blending the GAK 1 data set with the Seward Line sampling program. In particular, our focus here has been on understanding the variations in zooplankton abundance as a function of shelf conditions. We have also focused on understanding how springtime variability in zooplankton abundance and composition relate to variations in springtime stratification on the shelf.

j) Community Involvement/TEK and Resource Management Applications –

N/A

k) Information Transfer –

Publications:

Janout Markus A., Thomas J. Weingartner, Phyllis J. Stabeno, Air-sea and oceanic heat flux contributions to the heat budget of the northern Gulf of Alaska shelf, Journal of Geophysical Research (*in press*)

Conference and workshop presentations and attendance during the reporting period:

Kelly, James, and Thomas Weingartner, Seward sea level variability: Sources and implications, poster presented at Alaska Marine Science Symposium, Anchorage, Alaska, January 2013.

Data and/or information products developed during the reporting period:

Recent mooring data has been uploaded onto the GAK 1 website and is being prepared for the Gulfwatch Data Management Team. Historical GAK 1 data has been provided to this team.

I) Budget—

- There is no new information regarding in-kind, matching funds or other funds from non-Trustee Council sources for the project.

Budget Category:	Proposed Year 1	Actual Year 1	TOTAL Difference
Personnel	\$52,685	\$0	\$52,685
Travel	\$1,398	\$0	\$1,398
Contractual	\$22,920	\$0	\$22,920
Commodities	\$0	\$0	\$0
Equipment	\$10,015	\$0	\$10,015
Other	\$0	\$0	\$0
Indirect Costs (<i>will vary by proposer</i>)	\$13,436	\$0	\$13,436
SUBTOTAL	\$100,454	\$0	\$100,454
General Administration (9% of subtotal)	\$9,041	\$0	\$9,041
PROJECT TOTAL	\$109,495	\$0	\$109,495
Other Resources (Cost Share Funds)	\$0	\$0	\$0

COMMENTS: Invoices received to PWSSC through period ending 12/31/2012

FY12

**Program Title: 12120114-P,
Continuing GAK1 Monitoring
Team Leader: Weingartner**

SUMMARY

- a) Project Number— 12120114-J
- b) Project Title—Long-Term Program- Seward Line Monitoring
- c) Principal Investigator— Russ Hopcroft
- d) Time Period Covered by the Report—02/01/12 to 01/31/13
- e) Date of Report— 03/01/13
- f) Project Website— <http://www.sfos.uaf.edu/sewardline/>
- g) Summary of Work Performed—

The work performed remains consistent with the original workplan. The May 3-11 cruise accomplished all sampling objectives, except that a series of storms prevented Multinet collections at GAK3 & GAK4. The September 11-19 cruise was similarly challenged by weather, but all sampling was completed both along the Seward Line and in Prince William Sound (PWS). Most data is available from the May cruise, with the exception of the zooplankton which is incomplete. Processing of most collections remains underway for the September cruise. The 8 additional sampling stations in PWS were sampled both cruises.

Oceanographically, the Seward Line was at or slightly below the long-term mean temperature during the May 2012 cruise. Temperature during September were also unremarkable. Macro-nutrient and chlorophyll concentrations measured during May suggest the spring bloom was in progress along the Line during the cruise. The keystone zooplankton genus *Neocalanus* was slightly delayed in its life cycle, but near the long-term mean in terms its abundance. There were no notable anomalies during the spring for other species.

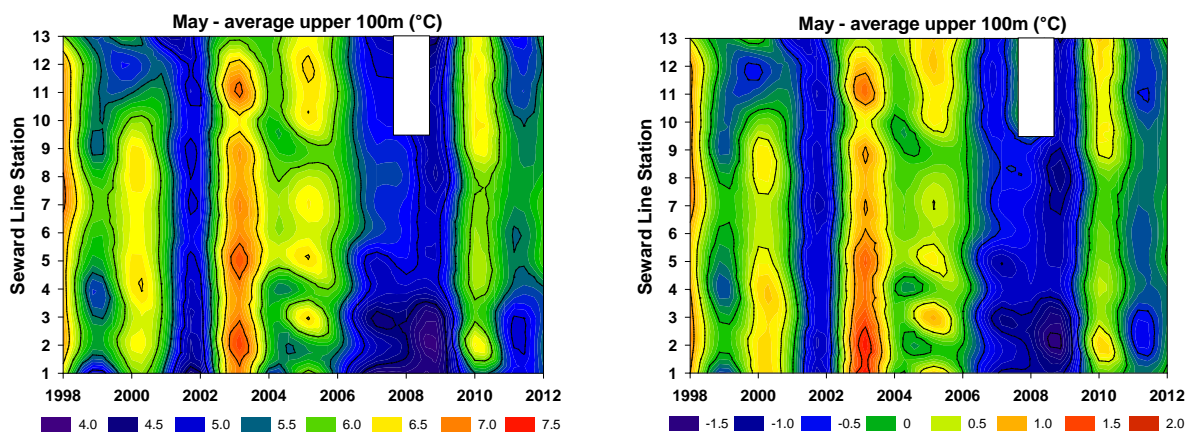

Temperature averages in the upper 100 m along the Seward Line in early May (left), along with their seasonal anomalies (right).

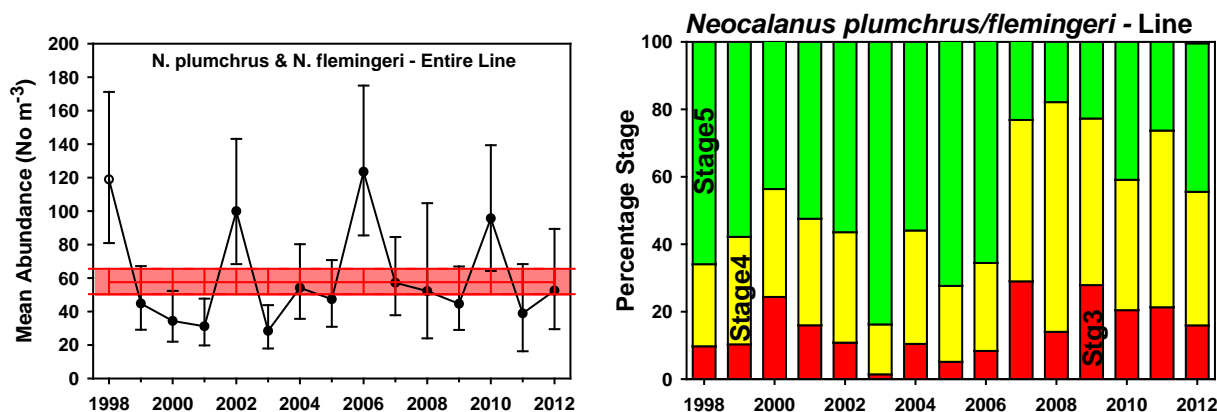

Abundance of the copepods *Neocalanus plumchrus/flemingeri*, averaged along the Seward Line in early May. The distribution of life-stages in May provides an index on the development/growth rates of the species, with more later stages indicating faster development.

h) Summary of Future Work to be Performed—

Efforts in 2013 remains as in the original workplan. Fieldwork in 2013 centers around the annual cruises to be run in May and September from the FWS vessel *Tiglax*. Processing of samples collected in 2012 and to be collected in 2013 will be the focus of lab-based activities.

i) Coordination/ Collaboration—

Hopcroft serves on the Science Coordinating Committee, and participates regularly in associated functions. He work in close collaboration with Weingartner's GAK1 project

j) Community Involvement/ TEK and Resource Management Applications—

Seward Line data has been passed to ADFG for use in PWS salmon forecasts.

k) Information Transfer—

Presentations:

Doubleday & Hopcroft. 2012. Estimates of the composition, abundance, and biomass of pteropods and larvaceans in the coastal Gulf of Alaska. ASLO/AGU Ocean Sciences Meeting – Salt Lake City, Utah

Doubleday & Hopcroft. 2013. Seasonal and inter-annual patterns of pteropod and larvacean estimates in the coastal Gulf of Alaska. Alaska Marine Science Symposium – Anchorage

Hopcroft. 2013. Measuring the pulse of the Gulf of Alaska: oceanographic observations along Seward Line, and in Prince William Sound 1997-2012. Alaska Marine Science Symposium – Anchorage

Holderied, McCammon, Hoffman, Rice, Ballachey, Weingartner, Hopcroft. 2013. Gulf Watch Alaska – Ecosystem monitoring at the intersection of spilled oil and climate change. Alaska Marine Science Symposium – Anchorage

Conferences & Workshops:

ASLO/AGU Ocean Sciences Meeting – Salt Lake City, Utah. February, 2012

NPRB Gulf of Alaska Project, PI meeting – Juneau, March 2012

Gulf Watch PI meeting Anchorage, November 2012

Alaska Marine Science Symposium – Anchorage, January 2013

I) Budget—

No changes: This project leverages off funding provided by AOOS and NPRB through their Gulf of Alaska IERP that combined provide ~2/3 of the annual costs to execute the Seward Line.

**EXXON VALDEZ OIL SPILL TRUSTEE COUNCIL
ANNUAL PROGRAM REPORT YEAR 1**

Budget Category:	Proposed Year 1	Actual Year 1	TOTAL Difference
Personnel	\$28,810	\$11,889	\$16,921
Travel	\$2,460	\$4,130	(\$1,670)
Contractual	\$49,000	\$48,877	\$123
Commodities	\$1,170	\$2,761	(\$1,591)
Equipment	\$0	\$0	\$0
Other	\$0	\$0	\$0
Indirect Costs (<i>will vary by proposer</i>)	\$8,600	\$5,154	\$3,446
SUBTOTAL	\$90,040	\$72,811	\$17,229
General Administration (9% of subtotal)	\$8,104	\$6,553	\$1,551
PROJECT TOTAL	\$98,144	\$79,364	\$18,780
Other Resources (Cost Share Funds)	\$0	\$0	\$0

.

FY12

**Program Title: 12120114-J, Seward Line
Monitoring
Team Leader: Hopcroft**

SUMMARY

- a) **Project Number**— 12120114-Q
- b) **Project Title**—Lingering Oil: Monitoring Shorelines and Nearshore Vertebrates in Prince William Sound. Part II: Evaluating the Chronic exposure of harlequin ducks and sea otters to lingering oil in western Prince William Sound
- c) **Principal Investigator**— B. Ballachey, J. Bodkin, D. Esler, A.K. Miles, and L. Bowen.
- d) **Time Period Covered by the Report**—02/01/12 to 01/31/13
- e) **Date of Report**— 03/01/13
- f) **Project Website**- N/A
- g) **Summary of Work Performed**—

The goal of this study is to evaluate the recovery status of harlequin ducks and sea otters in PWS using biomarker assays to assess continuing exposure to lingering oil. We captured sea otters (n = 60) in western PWS in July 2012, and collected blood for biomarker and health assays (using gene expression analyses), and body measurements to assess condition. Harlequin ducks were last sampled in March 2011 (under EVOS Restoration Project 11100808) and, at that time, elevated biomarker levels (cytochrome P4501A) were observed to persist in ducks from oiled areas, relative to those from unoiled areas. Thus we determined to defer sampling of harlequin ducks until 2013; that capture will be conducted during the first three weeks of March. Analyses of samples collected in 2012 and 2013 (gene expression on blood from sea otters, cytochrome P450 on liver from harlequin ducks) will be completed by mid-2013.

h) **Summary of Future Work to be Performed**—

There are no changes anticipated from the work plan submitted in 2011. The key milestones for the upcoming year will be capture and sampling of harlequin ducks, and completion of gene expression (otters) and cytochrome P450 (ducks) assays. Decisions on a schedule for subsequent samplings will be made based on results from years 1 (sea otters) & 2 (harlequin ducks).

i) **Coordination/ Collaboration**—

N/A

j) **Community Involvement/TEK and Resource Management Applications** –

N/A

k) **Information Transfer**—

Publications produced during the reporting period:

None applicable.

Conference and workshop presentations and attendance during the reporting period:

B. Ballachey & J. Bodkin, attended the November 2012 Gulf Watch Alaska PI meeting in Anchorage; B. Ballachey attended the January 2013 Alaska Marine Science Symposium in Anchorage.

Data and/or information products developed during the reporting period:

Multiple data sets were collected for sea otters during the 2012 capture and processing of samples; we are finalizing these data sets (completion of assays) and will then add metadata to the various data sets prior to placement on the AOOS workspace.

l) Budget—

**EXXON VALDEZ OIL SPILL TRUSTEE COUNCIL
ANNUAL PROGRAM REPORT YEAR 1**

Budget Category:	Proposed Year 1	Actual Year 1	TOTAL Difference
Personnel	\$0	\$0	\$0
Travel	\$10,000	\$1,250	\$8,750
Contractual	\$141,900	\$104,970	\$36,930
Commodities	\$35,500	\$752	\$34,748
Equipment	\$0	\$1,621	(\$1,621)
Other	\$0	\$0	\$0
Indirect Costs (<i>will vary by proposer</i>)	\$0	\$0	\$0
SUBTOTAL	\$187,400	\$108,592	\$78,808
General Administration (9% of subtotal)	\$16,900	\$16,900	\$0
PROJECT TOTAL	\$204,300	\$125,492	\$78,808
Other Resources (Cost Share Funds)	\$0	\$0	\$0

COMMENTS:

FY12	Program Title: 12120114-S, Lingering Oil: Part II, Evaluate chronic exposure of sea otters and harlequin ducks in PWS Team Leader: Ballachey (NOAA), Estler	SUMMARY
-------------	---	----------------

- a) **Project Number—** 12120114-S
- b) **Project Title—**Long-term monitoring: lingering oil
- c) **Principal Investigator—** Carls MG, Lindeberg M, and Rice SD
- d) **Time Period Covered by the Report—**02/01/12 to 01/31/13
- e) **Date of Report—** 03/01/13
- f) **Project Website—** N/A
- g) **Summary of Work Performed—**

Hydrocarbon measurement. Analytical chemical measures of polynuclear aromatic hydrocarbons (PAHs), alkanes, and biomarkers have been completed for several groups working in Prince William Sound (PWS) and the Gulf of Alaska; additional measurements are pending. These studies include analysis of sediment data from the bioremediation study (Boufadel et al), mussel tissue and sediment from the Long Term Environmental Monitoring Program (LTEMP; Payne et al), and long term monitoring in the Gulf of Alaska (Irvine et al).

Geochemical biomarkers. Measurement of geochemical biomarkers in some beaches has been completed 22 years after the Exxon Valdez oil spill; comparison to similarly analyzed fresh Exxon Valdez oil provides definitive confirmation that the oil originated from the Exxon Valdez and evidence that biomarkers are highly conserved (persistent) in intertidal environments.

Forensic chemistry and modeling. In conjunction with the projects above and other related projects, we have made progress in forensic chemistry; interpretation of numerical results requires mathematical tools and models to identify sources, understand time- and circumstance-dependent changes in the chemistry of released oil, and the biological implications of exposure.

Hydrocarbon database updates, maintenance, and quality assurance in preparation for release to principal investigators and for ERMA mapping and AOOS are underway. Work and involves several people; about 3500 records are being added, each containing roughly 100 fields partitioned among sample information and data tables.

h) Summary of Future Work to be Performed—

No changes to the original work plan are expected. Key milestones in the upcoming six months include:

- *Continued supplemental support analyses*
- *Planning for FY14 field work (beach sampling)*
- *Retrospective analysis of geochemical biomarkers in Exxon Valdez oil*

i) Coordination/ Collaboration—

We are collaborating with Boufadel et al, Payne et al, and Irvine et al to measure hydrocarbons with PWS and the Gulf of Alaska. Our analytical resources are available to all other Gulf Watch Investigators as needed. Collaborative vessel use for field work in FY14 is feasible.

j) Community Involvement/TEK and Resource Management Applications—

Project results will be presented at the AMSS meeting. Information on beach status will be provided to villages / towns in PWS.

k) Information Transfer—

Presentations were delivered at the annual principal investigator meeting. Principal investigator attended the 2013 Alaska Marine Science Symposium.

I) Budget—

- A detailed accounting of the project spending for the Federal fiscal year October 1, 2011 - September 30, 2012 is included on the following page.
- No budget changes have been made.

**EXXON VALDEZ OIL SPILL TRUSTEE COUNCIL
ANNUAL PROGRAM REPORT YEAR 1**

Budget Category:	Proposed Year 1	Actual Year 1	TOTAL Difference
Personnel	\$0		\$0
Travel	\$1,500	\$185	\$1,315
Contractual	\$14,000	\$16,500	(\$2,500)
Commodities	\$2,500	\$1,315	\$1,185
Equipment	\$0		\$0
Indirect Costs (will vary by proposer)			\$0
SUBTOTAL	\$18,000	\$18,000	\$0
General Administration (9% of subtotal)	\$1,620	\$1,620	\$0
PROJECT TOTAL	\$19,620	\$19,620	\$0
Other Resources (Cost Share Funds)	\$0	\$0	\$0

COMMENTS:

FY12

Program Title: Lingering Oil Monitoring
Team Leader: Mark Carls
Agency: NOAA / NMFS / Auke Bay Laboratories

SUMMARY

- a) **Project Number—** 12120114-C
- b) **Project Title—**Long-Term monitoring of seabird abundance and habitat associations during late fall and winter in Prince William Sound
- c) **Principal Investigator—** Mary Anne Bishop
- d) **Time Period Covered by the Report—**02/01/12 to 01/31/13
- e) **Date of Report—** 02/13/13
- f) **Project Website—** N/A
- g) **Summary of Work Performed—**

Pre-award we placed a seabird observer on two cruises, and post-award we placed a seabird observer on four cruises in Prince William Sound. Cruises were associated with two EVOS-funded projects: EVOS Gulfwatch *Humpback Whale systematic surveys* (n = 5) and the EVOS Herring and Research Monitoring *Juvenile Herring Abundance Index* (n = 1; Table 1).

Table 1. Seabird surveys in Prince William Sound associated with EVOS Gulfwatch and Herring Research & Monitoring surveys

Month	Year	Type	Dates
-------	------	------	-------

Oct	2011	whale	10/2-7/2011	The November 2012 cruise included transects in four bays (Simpson, Eaglek, Zaikof, and Whale) that have been surveyed twice per winter (November and March) since November 2007. A fifth bay, Lower
Dec	2011	whale	12/7-11/2011	
Feb	2012	whale	2/7-10/2012	
Oct	2012	whale	10/1-16/2011	
Nov	2012	herring	11/8-15/2012	
Dec	2012	whale	11/28/2012 - 12/3/2012	

Herring Bay on Knight Island has been surveyed twice per winter since November 2009.

We continued to use the same methodology on our cruises as that we have used since November 2007. That includes a 300m transect width (150 m each side), and recording all observations into dLog software. In total, 26 marine bird species were observed during the 6 surveys. The highest number of species was recorded in October both years (Table 2). Noteworthy is the December 2011 cruise characterized by rough seas, contributing to the low number of species observed compared with December 2012.

Table 2. Observations of seabird species by cruise during EVOS Gulfwatch and Herring Research & Monitoring surveys in Prince William Sound. Taxonomic Grouping refers to groups in Table 3.

Code	Taxonomic name	Taxonomic Grouping	Oct 2011	Dec 2011	Feb 2012	Oct 2012	Nov 2012	Dec 2012
	<i>Synthliboramphus</i>							
ANMU	<i>antiquus</i>	n/a	1			2		
BLKI	<i>Rissa tridactyla</i>	n/a	44	1		128	7	
BLSC	<i>Melanitta americana</i>	Deep Diver				1		
	<i>Brachyramphus</i>							
BRMU	<i>Brachyramphus</i> sp.	murrelet					2	
BUFF	<i>Bucephala albeola</i>	Shallow Diver						1
COLO	<i>Gavia immer</i>	Loon	4			1	1	2
COME	<i>Mergus merganser</i>	Merganser					1	5
COMU	<i>Uria aalge</i>	n/a	14	48	76	17	41	78
DCCO	<i>Phalacrocorax auritus</i>	Cormorant				1	2	2
FTSP	<i>Oceanodroma furcata</i>	n/a	10			3		
GWGU	<i>Larus glaucescens</i>	Large Gull	13	40	19	31	45	120
	<i>Histrionicus</i>							
HARD	<i>histrionicus</i>	Shallow Diver	1			6		8
HERG	<i>Larus argentatus</i>	Large Gull	2			1	19	
HOGR	<i>Podiceps auritus</i>	Grebe				1	1	
HOPU	<i>Fratercula corniculata</i>	Puffin	1					
LTDU	<i>Clangula hyemalis</i>	Deep Diver		1	3		2	10
	<i>Brachyramphus</i>							
MAMU	<i>marmoratus</i>	murrelet		15		7	6	32
MEGU	<i>Larus canus</i>	Small Gull		8	5	37	6	54
PALO	<i>Gavia pacifica</i>	Loon		8		4		13
	<i>Phalacrocorax</i>							
PECO	<i>pelagicus</i>	Cormorant	4	8	4	23	27	37
PIGU	<i>Cephus columba</i>	n/a	1			8		8

RNGR	<i>Podiceps grisegena</i>	Grebe					2	1
RTLO	<i>Gavia stellata</i>	Loon			2	1		
SOSH	<i>Puffinus griseus</i>	Shearwater	2					
TUPU	<i>Fratercula cirrhata</i>	n/a	17			1		
UNAL	Unidentified alcid	n/a		1		2		1
UNAU	Unidentified auklet	n/a				1		
UNCO	Unidentified cormorant	Cormorant					2	1
UNDU	Unidentified duck	n/a				1	2	5
UNGR	Unidentified grebe	Grebe					1	
UNGU	Unidentified gull	n/a	3	1	4	47	10	17
UNLO	Unidentified loon	Loon	1	2	5	6	3	13
	Unidentified							
UNME	merganser	Merganser					1	
UNPU	<i>Fratercula</i> sp.	Puffin	1					
	Unidentified							
UNSH	shearwater	Shearwater				1		
WWSC	<i>Melanitta fusca</i>	Shallow Diver	1	3		9	4	6
YBLO	<i>Gavia adamsii</i>	Loon		1			1	8
Total species observed			14	10	6	21	16	16

There were pronounced seasonal differences (Table 3) in species occurrence, with some species or species groups observed only in October both years: shearwaters, Fork-tailed Storm-Petrel, Ancient Murrelet and puffins (both Tufted and Horned). Black-legged Kittiwakes were in very low numbers or absent during December and February cruises.

Table 3. Density (number of birds/km²) by species or species group during Prince William Sound winter cruises.

	<u>Winter 2011-12</u>			<u>Winter 2012-13</u>		
	Oct	Dec	Feb	Oct	Nov	Dec
Loon	0.15	0.29	0.10	0.37	0.40	1.63
Grebe	0	0	0	0.01	0.06	0.02
<u>Procellarids</u>						
Shearwater	0.13	0	0	0.01	0	0
Fork-tail Storm Petrel	0.11	0	0	0.06	0	0
Cormorant	0.14	0.19	0.08	0.62	0.88	1.22
Merganser	0	0	0	0	0.21	0.11
<u>Gulls</u>						
Large gull	0.15	1.12	0.28	0.57	1.29	4.31
Small Gull	0	0.17	0.28	0.68	0.19	3.10
Black-legged Kittiwake	0.94	0.02	0	3.51	0.13	0
<u>Alcids</u>						
Common Murre	0.51	1.51	1.54	2.04	3.04	4.19
Brachyramphus Murrelet	0	0.79	0	0.20	0.32	1.33
Ancient Murrelet	0.04	0	0	0.07	0	0
Pigeon Guillemot	0.01	0	0	0.33	0	0.14
Puffin	0.27	0	0	0.01	0	0
<u>Ducks</u>						
Shallow Divers	0.03	0	0	0.24	0	1.10
Deep Divers	0.01	0.91	0.19	0.48	0.47	1.01

Numbers of Common Murre, the most numerous marine bird observed in Prince William Sound in winter, increased over the course of both winters. Brachyramphus Murrelets (almost exclusively Marbled Murrelet, *Brachyramphus marmoratus*) were not observed in the Sound in October, a time period that coincides with their molt. However by November and December, numbers increased, but then dropped by February (Fig. 1).

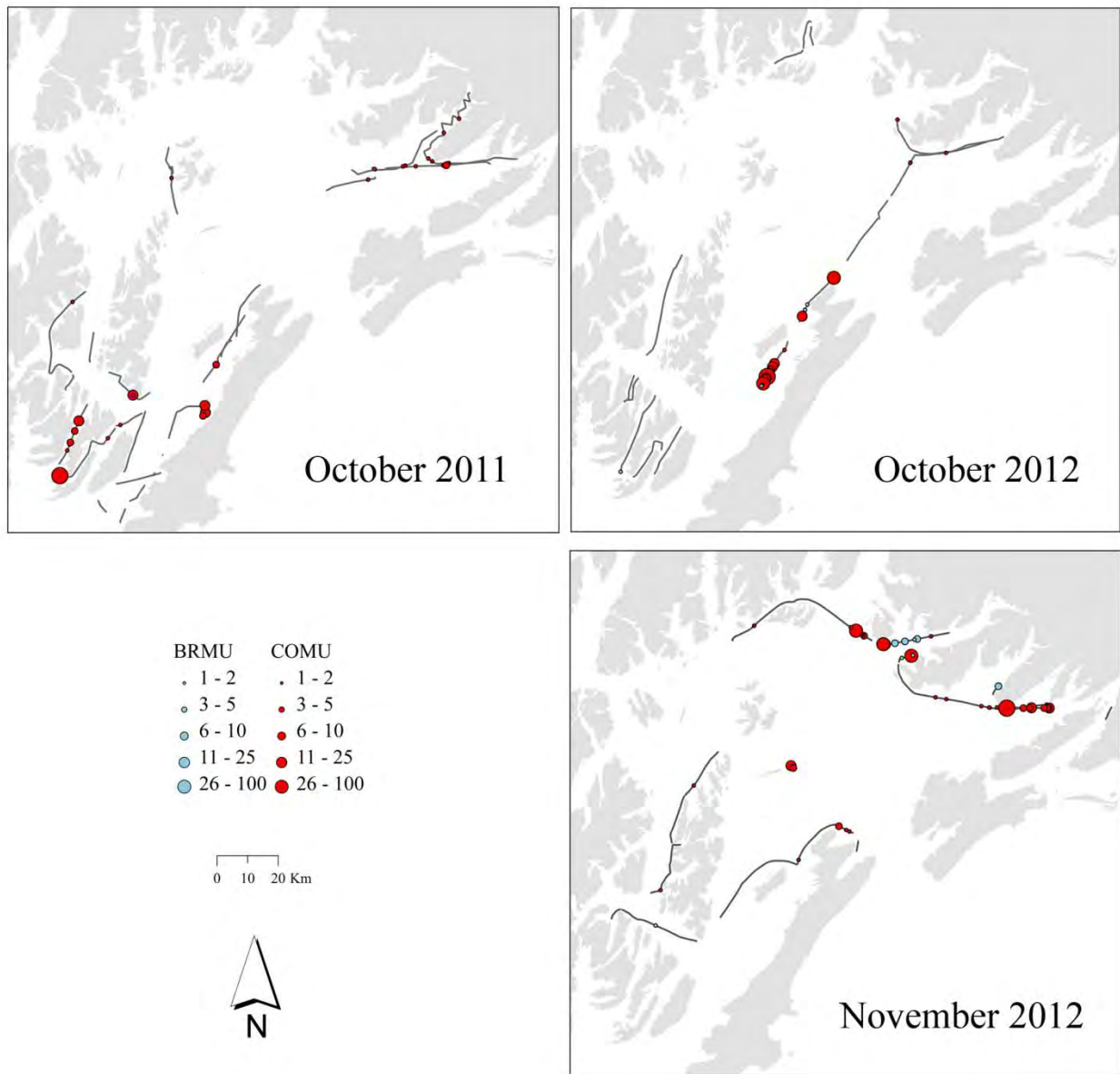

Figure 1. (continued below) Locations and relative abundances of seabird observations during EVOS Gulfwatch and Herring Research & Monitoring winter surveys in Prince William Sound. The first winter of surveys is shown in the left column; the second winter is shown in the right column.

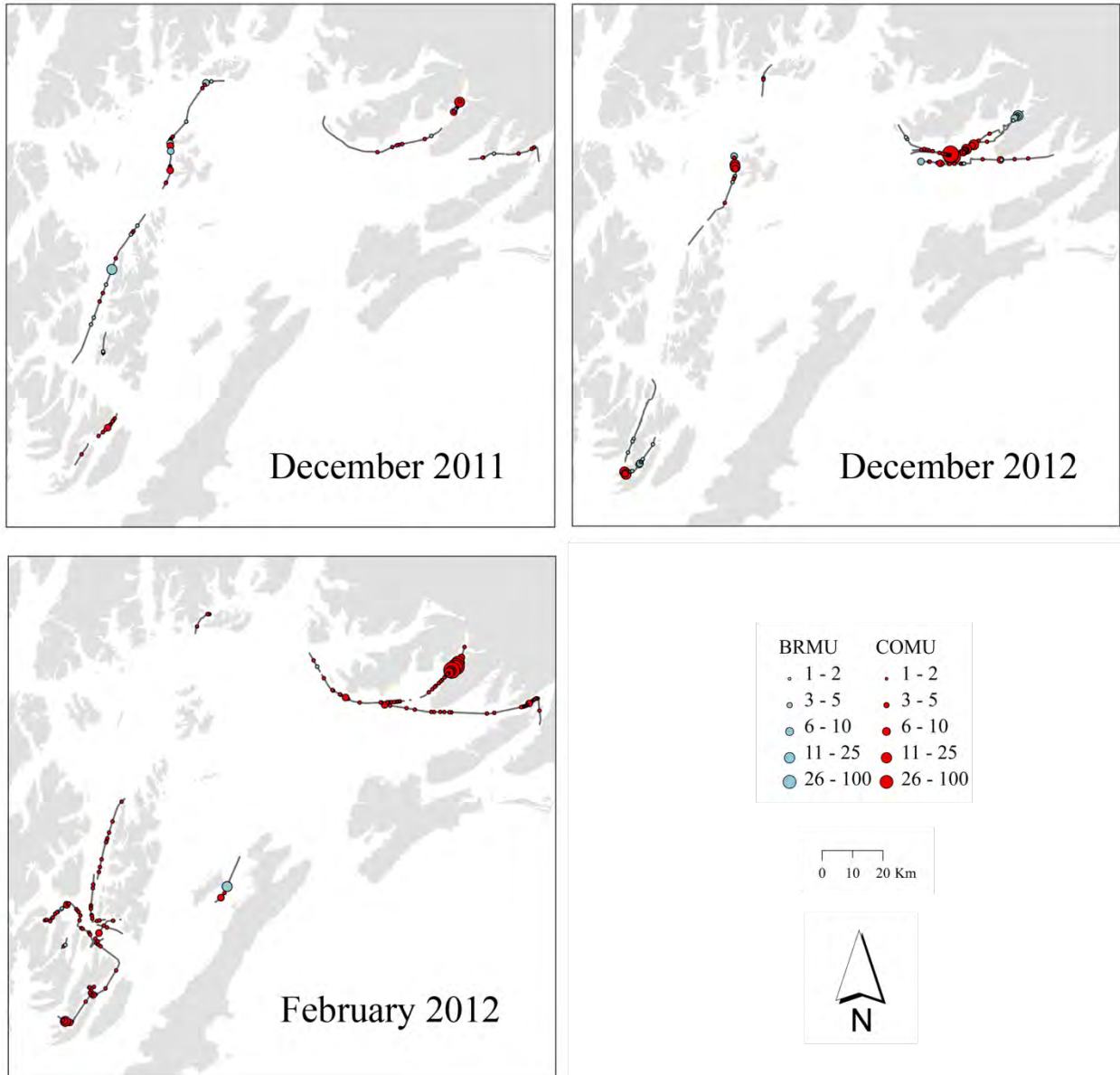

Figure 1. Locations and relative abundances of seabird observations during EVOS Gulfwatch and Herring Research & Monitoring winter surveys in Prince William Sound. The first winter of surveys is shown in the left column; the second winter is shown in the right column.

Personnel did change since the initiation of this project in October 2011. Mr. Bobby Hsu left the project as of May 2012 in order to go to graduate school. His replacement, Ms. Jessica Stocking, arrived in October 2012.

h) Summary of Future Work to be Performed –

In the next 6 months, seabird observers will be onboard during two cruises during spring 2013. The February 2013 onboard *Humpback Whale systematic surveys* has been rescheduled for early April 2013. The second cruise will be the HRM Expanded Adult Herring surveys (late March/early April). Fall 2013 will repeat monthly cruises from October through December. In addition, to cruises, data analyses will be ongoing.

i) Coordination/ Collaboration—

Our project relies totally on collaboration with EVOS Gulfwatch and Herring Research & Monitoring projects. Since October 2011, our seabird observers were onboard *Humpback Whale systematic surveys* (Oct and Dec 2011, Feb, Oct and Dec 2012) and the *Juvenile Herring Abundance Index* (Nov 2012). When not conducting daytime seabird surveys, observers assist the other projects, including helping to process the nighttime herring catch and helping identify humpback whales.

j) Community Involvement/TEK and Resource Management Applications—

While our project does not formally have a community involvement/TEK component, we have contact with the COASST coordinator for this region (A. Harding) that monitors some of the local beaches for seabird carcasses. The P.I. also has a salvage permit that allows citizens to give salvaged water birds to the P.I.

k) Information Transfer—

- Publications produced during the reporting period;
Hsu, B. 2012. Birds of a feather. *Delta Sound Connections* (This annual, free newspaper on science activities in Prince William Sound and the Copper River Delta prepared for general distribution to tourists visiting the area.)
- Conference and workshop presentations and attendance during the reporting period;
Gulfwatch Principal Investigators Meeting, Anchorage, Alaska. November 2012.
Presentation.
Alaska Marine Science Symposium, Anchorage, Alaska. January 2013. Attended.
- Data and/or information products developed during the reporting period.
10100132-H and 070814)

l) Budget—

**EXXON VALDEZ OIL SPILL TRUSTEE COUNCIL
ANNUAL PROGRAM REPORT YEAR 1**

Budget Category:	Proposed Year 1	Actual Year 1	TOTAL Difference
Personnel	\$46,000	\$0	\$46,000
Travel	\$0	\$0	\$0
Contractual	\$0	\$0	\$0
Commodities	\$0	\$0	\$0
Equipment	\$0	\$0	\$0
Other	\$1,400	\$0	\$1,400
Indirect Costs (<i>will vary by proposer</i>)	\$0	\$0	\$0
SUBTOTAL	\$47,400	\$0	\$47,400
General Administration (9% of subtotal)	\$4,266	\$0	\$4,266
PROJECT TOTAL	\$51,666	\$0	\$51,666
Other Resources (Cost Share Funds)	\$0	\$0	\$0

COMMENTS: No cost incurred by PWSSC through period ending 1/31/13. Notes - Activities on this project began in October 2011 prior to the Feb 2012 award. Seabird observers were on field cruises in Oct & Dec 11 and then again in Feb, Oct, Nov & Dec 2012. Other work was also conducted on this project. Inadvertantly personnel time for this work was charged to a corresponding EVOS project. We anticipate expending Year One funds in the immediate future.

FY12

**Program Title: 12120114-C, Seabird
Abundance in Fall and Winter
Team Leader: Bishop**

SUMMARY

- a) [Project Number— 12120114-K](#)
- b) [Project Title—Continuing the Legacy: Prince William Sound Marine Bird Population Trends](#)

- c) **Principal Investigator**— Kathy Kuletz and David Irons
- d) **Time Period Covered by the Report**—02/01/12 to 01/31/13
- e) **Date of Report**— 03/01/13
- f) **Project Website**- N/A
- g) **Summary of Work Performed**—

We successfully completed our planned marine bird survey of Prince William Sound (PWS) in July 2012. Pre-season work involved hiring a project leader (Cushing) and eight other observers to conduct the fieldwork, planning logistics for the field campaign, and removing the boats and other equipment from storage and preparing them for the survey.

2012 was a relatively cold and wet summer. Our field season was challenging, in part due to weather and to several major mechanical failures in our fleet of survey vessels, some of which have now been in service for 30 years. However, we were able to safely and successfully meet all of our data collection objectives within our schedule. This included over 2000 linear kilometers of marine bird surveys.

One observation of interest this year was about 10 Kittlitz's murrelets in the general vicinity of Cordova. This is somewhat unusual because the majority of these birds are associated with tidewater glaciers in PWS. We also observed several groups of Sabine's Gulls, which are infrequently observed in PWS.

We have completed post-season data entry and management, and have begun data analysis. Using the statistical methods described in our project plan, we have generated abundance estimates for a group of marine bird taxa described in the plan.

h) **Summary of Future Work to be Performed**—

During the upcoming reporting period, we will estimate PWS-wide population abundance trends over the period 1989-2012 for the marine bird taxa described in the research plan.

i) **Information Transfer**—

- **Conference Presentations**
 - Cushing, D.A., D.D. Roby, K.J. Kuletz, and D.B. Irons. 2013. Changes in abundance of *Brachyramphus* murrelets in Prince William Sound, Alaska, 1989-2012. Gulf of Alaska Plenary Session, Alaska Marine Science Symposium, Anchorage, Alaska.
- **Conference Attendance**
 - Alaska Bird Conference, October 2012, Anchorage, Alaska: Kuletz, Irons
 - Alaska Marine Science Symposium, January 2013, Anchorage, Alaska: Kuletz, Irons, Cushing

j) **Budget**

**EXXON VALDEZ OIL SPILL TRUSTEE COUNCIL
ANNUAL PROGRAM REPORT YEAR 1**

Budget Category:	Revised Year 1	Actual Year 1	TOTAL Difference
Personnel	99,950	100,648	(698)
Travel	11,815	24,056	(12,241)
Contractual	37,100	12,000	25,100
Commodities	34,580	46,387	(11,807)
Equipment	6,000	8,203	(2,203)
Other	0	0	0
Indirect Costs (<i>will vary by proposer</i>)	0	0	0
SUBTOTAL	189,445	191,294	(1,849)
General Administration (9% of subtotal)	17,050	17,216	(166)
PROJECT TOTAL	206,495	208,511	(2,016)
Other Resources (Cost Share Funds)	\$0	\$0	\$0

COMMENTS: Costs for a contract was less because we stayed at a lodge and in towns rather than chartering a boat. This increased the costs of travel and commodities. Several mechanical breakdowns of our old boats and motors also increased commodities.

FY12

**Program Title: 12120114-K, PWS Marine Birds Surveys
Team Leader: Irons (USGS), Kuletz (USFWS)**

SUMMARY

- a) **Project Number**— 12120114-F
- b) **Project Title**—Data synthesis, analysis and recommendations for sampling frequency and intensity of nearshore marine birds to detect trends utilizing existing data from the Prince William Sound, Katmai and Kenai Fjords coastlines
- c) **Principal Investigator**— Heather Colletti
- d) **Time Period Covered by the Report**—02/01/12 to 01/31/13
- e) **Date of Report**— 03/01/13
- f) **Project Website**— N/A
- g) **Summary of Work Performed**—

In mid-September we met with subject matter experts to refine approaches and finalize the proposal for the bid process. The resulting proposal is summarized below and is currently going through final review before beginning the bid process.

In the original planning schedule, the subject matter experts meeting was to take place in June 2012, allowing for the proposal to go out to bid in late June or early July of 2012, but because the meeting was delayed into late fall of 2012, we decided it best to carry over the funds into the next federal fiscal year (FFY13). Further complications arose as NPS converted to a new financial system and did not accept contract packages until early calendar year of 2013. It is now our intent to put a proposal out for bid and allocate the funds by the end of calendar year spring 2013 (FY13), and that work will be completed by January of 2014.

Summarized Proposal:

Initial analyses for NPS data (KATM and KEFJ) have shown high variability, making trend detection somewhat difficult. We recognize that variability is influenced by several factors including, but not limited to:

1. Individuals in groups are not independent
2. Imperfect detection
3. Habitat preferences by species. Habitat is treated as homogeneous across transects
4. Annual variation in distribution (i.e., availability) relative to our sampling area – By availability we mean birds present and subject to counts.
5. Within-season variation in distribution – birds may utilize home ranges that are larger than individual transects, and any individual that utilizes a given transect during the season may or may not be present and subject to being detected and counted at any given sampling occasion. Birds may also utilize home ranges that overlap multiple transects.

We anticipate that we will be able to detect large (>50%) changes in abundance for relatively common species, but have recently considered other questions of interest. We propose utilizing this data in an occupancy framework. Occupancy, defined here as the proportion of area occupied, may provide useful information regarding species distribution, habitat preferences or availability by species, and rates of extinction and colonization (species richness) by area (MacKenzie et al. 2006). As potential stressors to a system such as climate change, invasive species and other anthropogenic factors increase, understanding how a species or community is responding to those changes through changes in distribution may be informative for resource managers trying to assess park or regional resources and appropriate management actions.

While all species are identified and enumerated during the surveys, analyses suggested here will be done for two or three species that may represent a range of abundances as well as distribution. Because we don't account for imperfect detection in our survey methods and occupancy modeling requires an estimate of detection, we propose an approach used by Hines et al. (2010) allowing the use of spatial replicates for occupancy modeling.

Hines, J. E., J. D. Nichols, J. A. Royle, D. I. MacKenzie, A. M. Gopalaswamy, N. Samba Kumar, and K. U. Karanth. 2010. Tigers on trails: occupancy modeling for cluster sampling. *Ecological Applications* 20(5) 1456-1466.

MacKenzie, D. I., J. D. Nichols, J. A. Royle, K. H. Pollock, L. A. Bailey, and J. E. Hines. 2006. *Occupancy modeling and estimation*. Academic Press, San Diego, California, USA.

h) Summary of Future Work to be Performed—

Because of some unanticipated delays, our timeline for completion of analysis has been shifted to a later date. We expect a proposal to go out for bid in the spring of 2013, a contract to be awarded by summer of 2013 and the analyses to be completed by January 2014.

i) Coordination/ Collaboration—

Coordination and collaboration of our work with other components of the project are proceeding with no concerns.

j) Community Involvement/TEK and Resource Management Applications—

This section shall describe efforts undertaken during the reporting period to achieve the community involvement/TEK and resource management application provisions of the proposal, *if applicable*.

k) Information Transfer—

- Publications produced during the reporting period:

There were no publications produced regarding this work during this time period.

- Conference and workshop presentations and attendance during the reporting period; and
 - November 2012 PI meeting: attended by Ballachey, Bodkin, Coletti, Dean, Irons
 - January 2013 AK Marine Science Symposium: attended by Ballachey, Coletti, Irons
 - Posters presented at 2013 AMSS:
 - Katrina L. Counihan-Edgar, Tuula Hollmen, and **Heather Coletti**. *Physiological assessment of Mytilus spp. in Kenai Fjords National Park*.
 - Brooke Carney, David Tessler, **Heather Coletti**, and Douglas Causey. *Long-term diets of Black Oystercatchers (Haematopus bachmani), evidence from stable isotopes - preliminary results*.
 - **Heather Coletti, James L. Bodkin, Brenda E. Ballachey, Thomas A. Dean, Katrin Iken, Kimberly A. Kloecker, Brenda Konar, Mandy Lindeberg, and Daniel Monson**. *Monitoring nearshore marine ecosystems in the Gulf of Alaska: Detecting change and understanding cause*.
- Data and/or information products developed during the reporting period:
 - Survey data is collected annually. We are currently in the process of adding metadata for placement on the AOOS workspace. The data collected from Katmai National Park and Preserve (2006-2010) and Kenai Fjords National Park (2007-2010) has been uploaded to eBird (<http://ebird.org/content/ebird/>) through an agreement NPS had with the Alaska Natural Heritage Program. This data collection was funded in full by NPS and is publically accessible. This data will also be used in the proposed analysis.

I) Budget—

**EXXON VALDEZ OIL SPILL TRUSTEE COUNCIL
ANNUAL PROGRAM REPORT YEAR 1**

Budget Category:	Proposed Year 1	Actual Year 1	TOTAL Difference
Personnel	\$0		\$0
Travel	\$0		\$0
Contractual	\$30,000	\$0	\$30,000
Commodities	\$0		\$0
Equipment	\$0		\$0
Indirect Costs (<i>will vary by proposer</i>)	\$0		\$0
SUBTOTAL	\$30,000	\$0	\$30,000
General Administration (9% of subtotal)	\$2,700	\$0	\$2,700
PROJECT TOTAL	\$32,700	\$0	\$32,700
Other Resources (Cost Share Funds)	\$20,000	\$5,000	\$0

COMMENTS: Budget projections more or less on target for what we projected. Due to delays in meetings with subject matter experts and some administrative delays, we are anticipating a contract will be submitted for bids by spring of 2013. In-kind contributions will be for the staff time, primarily from NPS (approximately 2 months of a GS12), but also from USFWS and USGS, to gather and provide the data to the contractor as well as provide expertise as to ecosystem processes and provide assistance in the compilation and reporting of results.

PI: Heather Coletti
Project #: 12120114-F

Title: Data synthesis, analysis and recommendations for sampling frequency and intensity of nearshore marine bird surveys to detect trends utilizing existing data from the Prince William Sound, Katmai and Kenai Fjords coastlines.

- a) **Project Number—** 12120114-M
- b) **Project Title—**Long-Term killer whale monitoring in Prince William Sound/ Kenai Fjords
- c) **Principal Investigator—** Craig O. Matkin
- d) **Time Period Covered by the Report—**02/01/12 to 01/31/13
- e) **Date of Report—** 03/01/13
- f) **Project Website—** www.whalesalaska.org, alaskawhalesightings.com
- g) **Summary of Work Performed—**

February –April 2012. The current killer whale photographic reference catalogue was reworked and brought up to date. Data on all matriline photographed in 2012 was brought up to date in our matriline diagrams. The updated catalogue was provided to all tourboat operators and to the National Park Service. A publication on AT1 and Gulf of Alaska transient killer whale population trajectories and range was completed (see below). Preparation for field work also occurred in this period.

May-October 2012. All fieldwork occurred during this period. During 58 days of fieldwork we logged 47 encounters with killer whales, 38 with residents, 4 with AT1 transients, 3 with Gulf of Alaska transients and 2 with offshores. Forty of the encounters were logged by the R.V. *Natoa* and 7 by other vessels with NGOS personnel on board. All of the matriline used in long

term population analysis were photographed except two matriline in the AN10pod. This is considered an excellent season in regard population monitoring. We collected 9 biopsy samples during the field season. We are attempting to resampling particular individuals several times over the course of the season to examine changes in lipids reflective of diet changes and to calibrate readings from other samples. This has proven more challenging than expected due to sequential use of the area by different pods and slowed our chemical feeding habits work. We did manage to sample one individual (AJ32), early, mid, and late season. Analysis is in process for all samples. We also collected 7 scale samples from kill sites that are in analysis. Spring samples from Prince William Sound have been difficult to obtain as has been the case in previous years. We attached tags to 6 whales. All but one tag provided time/depth information (Mark 10 tag/Wildlife Computers) as well as location (an in initial proposal). We are now attempting to calibrate time/depth of dive with feeding behavior to better define important feeding areas. Tags deployed lasted an average of two weeks. The shorter times seem linked to the Mark 10 tags which are still being refined; however, the dive data has already provided unique and novel results (recording dives of up to 500m) and an opportunity to link dive profiles with feeding behavior. The use of Mark10 tags is a departure from the proposed use of location only tags, but represents a significant step forward. We began the process of long term data archiving of all our data with the photoidentification data with Sarah Clark at National Center for Ecological Analysis and Synthesis. She is now publishing that data

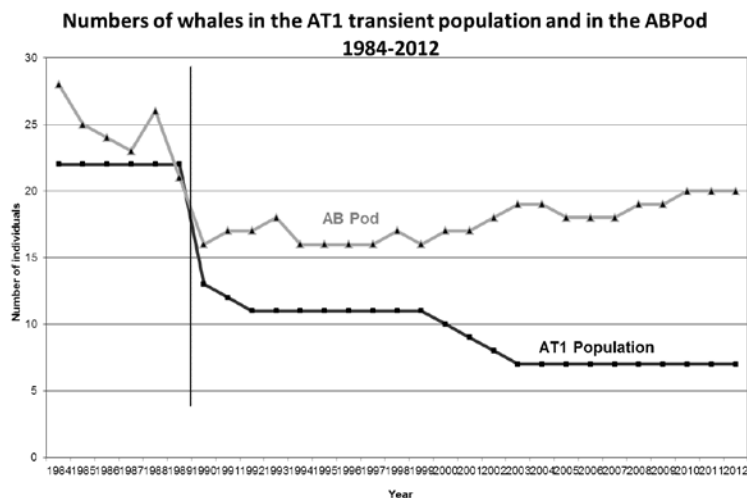

October 2012-January 2013. Photo analysis was completed during this period. A presentation was prepared and delivered at the annual Gulf Watch meeting in November. We updated numerous databases at NGOs including survey and encounter access database, matriline tables, and biopsy and tagging summaries. We filtered tagging data and constructed maps and tracks and associated dive data for tagged whales. Samples of tissue and scales were sent out for analysis. We completed a humpback whale catalogue and sighting history tables for humpback whales in Kenai Fjords to complement work done by Project 12120114-N, Humpback Whale Predation on Herring in Prince William Sound. We supplied our humpback whale photo-identification and encounter data to Project 12120114-N of the story of the AT1(Chugach) transients was presented at the Maui WhaleTails

conference. The book “Into Great Silence”, the story of the AT1 (Chugach) transients was released. We helped the National Resources Defense Council construct an interactive web exercise that will use the results of our research to educate users on the effects of the Exxon Valdez oil spill on killer whales.

We followed our list of objectives as stated in the original proposal, although we are expanding the tagging effort to use the new time/depth recording Mark 10 tags. The greatest challenges have been in attempting to re-biopsy specific whales over the course of the season and in the collection of scales from predation events in spring in Prince William Sound. We have emphasized public outreach to a greater extent than originally planned, in part due to the release of the book on AT1 (Chugach) transient killer whales. Outreach included the creation of a Facebook site for the North Gulf Oceanic Society that allows quicker posting of events and more direct interaction than the website.

h) Summary of Future Work to be Performed—

We will be completing our analysis and finalizing the updates to the killer whale catalogue for distribution to operators and other interested parties this spring via posting on our website. We are completely revamping our main website to bring it up to date and make our reports, catalogues (including our Kenai Fjords humpback catalogue), and books more accessible. Presentations from our new book “Into Great Silence” (the story of the AT1 or Chugach transients) by Eva Saulitis will be given in Boston, New York, Los Angeles as well as in Anchorage, Homer, and Kodiak Alaska. Preparation for fieldwork will begin in early April and the first cruise is scheduled for mid May. We are completing a paper on humpback whale interaction/predation by killer whales to be submitted this spring.

i) Coordination and Collaboration—

We collaborate most closely with Project 12120114-N, Humpback Whale Predation on Herring in Prince William Sound, collecting data for that project when possible and coordinating our research schedules. We have provided our data and assisted in placing it in a long-term database at the National Center for Ecological Analysis and Synthesis.

j) Community Involvement/ TEK and Resource Management Applications – N/A

k) Information Transfer –

We work closely with the tourboat operators in Kenai Fjords and one of our researchers also operates tourboats (Dan Olsen) and provides an excellent conduit to the over 100,000 visitors to Kenai Fjords each year. We make presentations to the National Park Service and tourboat operators each year and have multiple websites that provide information on our work and provide catalogues of humpback and killer whales. We have membership on the Alaska Scientific review group that reviews stock assessments for killer whales and humpback whales annually and our data is incorporated into those assessments.

l) Budget—

Our budget has always run over six months behind the actual fiscal year for NOAA (October-September) because of the NGOS fiscal year which ends May 31. Although this has been the accepted case with the NMFS/NOAA financial office for two decades, this might be unfamiliar

to the PWSSC as they assume financial control of the project. The FY2011 budget/expenditure final totals can be submitted on request.

We expect to run our final category totals to within 10% of projected costs although we cannot be certain until the end of our accounting year. We will remain within budget for the project.

**EXXON VALDEZ OIL SPILL TRUSTEE COUNCIL
ANNUAL PROGRAM REPORT YEAR 1**

Budget Category:	Proposed Year 1	Actual Year 1	TOTAL Difference
Personnel	\$0	\$0	\$0
Travel	\$0	\$0	\$0
Contractual	\$0	\$0	\$0
Commodities	\$6,000	\$0	\$6,000
Equipment	\$0	\$0	\$0
Other	\$0	\$0	\$0
Indirect Costs (<i>will vary by proposer</i>)	\$600	\$0	\$600
SUBTOTAL	\$6,600	\$0	\$6,600
General Administration (9% of subtotal)	\$594	\$0	\$594
PROJECT TOTAL	\$7,194	\$0	\$7,194
Other Resources (Cost Share Funds)	\$0	\$0	\$0

COMMENTS: Invoices received to PWSSC through period ending 12/31/2012, No expenditures recieved to date

FY12

**Program Title: 12120114-M, Long
Term Killer Whale Monitoring
Team Leader: Matkin**

SUMMARY

- a) **Project Number**— 12120114-N
- b) **Project Title**—Long-Term monitoring: Pelagic Monitoring Component- Long- Term monitoring of humpback whale predation on Pacific Herring in Prince William Sound
- c) **Principal Investigator**— John R. Moran (NOAA) and Janice M. Straley (UAS)
- d) **Time Period Covered by the Report**—02/01/12 to 01/31/13
- e) **Date of Report**— 03/01/13
- f) **Project Website**— N/A
- g) **Summary of Work Performed**—

During the reporting period, three week-long humpback whale and whale prey surveys were completed (Feb. 2012, Sept. 2012, and Dec. 2012). Two other opportunistic surveys were completed in conjunction with the Auke Bay Laboratories Ocean Acidification program (April 2012 and Aug. 2012).

Photographic data collected during reporting period has been entered into the Prince William Sound database. Complete matching of flukes has occurred for all NOAA/UAS funded data; whale identification catalogs have been created and distributed to colleagues.

Data management has begun to be submitted to Matt Jones and colleagues.

h) Summary of Future Work to be Performed—

We will complete the final whale survey of the 2012/2013 field season during April 2013. Some prey data remains to be entered.

Charters need to be secured for the upcoming field season (October, December, and April). We will conduct three surveys during the 2013/2014 field season with some adjustments in the timing and duration. We will schedule the surveys for seven rather than six days. This will allow us an extra day if necessary for weather. We will move the February survey to early April to monitor predation by whales on pre-spawning and spawning herring. Although late-winter whales are present in PWS; their numbers have been consistently low with minimal impact on herring. Because whale numbers are higher in early April and they are targeting herring, we feel this will be a more productive time to conduct our third survey.

i) Coordination/ Collaboration—

We have provided killer whale photos and recordings to Craig Matkin from each survey. Bobby Hsu from the PWSSC was present on the Feb. survey as a seabird observer Jen Cedarleaf replaced him on the Sep. and Dec. surveys. We provided brand resights and haulout photos of northern sea lions to ADF&G.

We are currently processing humpback whale data collected by Craig Matkin in PWS and Kenai Fjords under his EVOS funding. Straley and/or Moran have attended all the PI meetings by audio or in person.

j) Community Involvement/ TEK and Resource Management Applications—

Straley and Moran were invited to Honolulu by the West Pacific Fisheries Management Council to provide information on humpback whale predation in Alaska. Straley presented to the Advisory Panel in May and Moran gave presentations to the Advisory Panel, Council, and the Fishers Forum in June Straley was invited to present at the PWSRCAC Science Night in Anchorage.

k) Information Transfer—

Publications produced during the reporting period:

In review at Fisheries Oceanography-

John R. Moran, Janice M. Straley, Stanley D. Rice, Ron Heintz, Terrence J. Quinn II, and Suzanne F. Teerlink. Late-season abundance and seasonal trends of humpback whales on three important wintering grounds for Pacific herring in the Gulf of Alaska.

Janice Straley, John Moran, Johanna Vollenweider, Kevin Boswell, Kate McLaughlin, Andy McLaughlin, Ron Heintz and Stanley Rice. A comparison of the diet, habitat use and impact of humpback whale predation upon three overwintering herring populations in the Gulf of Alaska.

Kevin M. Boswell, Johanna J. Vollenweider, John R. Moran, Ron A. Heintz, Jason K. Blackburn, David J. Csepp. Humpback whale foraging structures winter schooling behavior of Pacific herring and facilitates commensal predation by multiple predators.

Ron A. Heintz, John Moran, Janice Straley, Johanna J. Vollenweider, Kevin Boswell and Stanley D. Rice. Regional Variation in the Intensity of Humpback Whale Predation on Pacific Herring in the Gulf of Alaska.

Conference and workshop presentations:

Moran and Straley attended and presented at the Alaska Marine Science Symposium in Anchorage.

l) Budget—

Note: PI Straley's budget is not reflected in this report. It will be submitted to directly NOAA grants and contracts.

Our fiscal year budget does not correspond with the timing of our field work. This is the result of several factors:

We did not receive FY 12 funding until November of 2011. This delay in funding would have resulted in us missing most of the 2011/2012 winter field season setting us a year behind in the project, however, we were able to spend against other budgets with the assurance that the money would arrive.

Further complicating matters, our field season straddles federal fiscal year and NOAA spending ceases during August and September to consolidate budgets. This requires us to secure contracts

for the next winter's field work by the end of July. Thus, some budget items, such as vessel charters and travel, will continue to be funded from the previous year's budget.

**EXXON VALDEZ OIL SPILL TRUSTEE COUNCIL
ANNUAL PROGRAM REPORT YEAR 1**

Budget Category:	Revised Year 1	Actual Year 1	TOTAL Difference
Personnel	\$2,000.0	3,000	(1,000)
Travel	\$5,400.0	13,000	(7,600)
Contractual	\$103,500.0	133,000	(29,500)
Commodities	\$6,000.0	2,000	4,000
Equipment	\$0.0	5,000	(5,000)
Other	0	0	0
Indirect Costs (will vary by proposer)	0	0	0
SUBTOTAL	116,900	156,000	(39,100)
General Administration (9% of subtotal)	10,500	14,000	(3,500)
PROJECT TOTAL	127,400	170,000	(42,600)
Other Resources (Cost Share Funds)	\$25,000	\$0	\$0

COMMENTS: Due to the timing of our field work in relation to the EVOS Budget years, and that our field season straddles the federal fiscal year we have needed to spend into our EVOS Year two funds in advance of the EVOS Budget (ear Feb 1 - Jan 31). Because of the difference in timeline, this requires us to secure contracts for the next winters field work by the end of July. Thus, some budget items, such as vessel charters and travel, will continue to be funded from the next year's budget.

FY12-16

**Program Title: 12120114-N, Humpback Whale
Predatiojn on Herring
Team Leader: Moran/Straley**

SUMMARY

- a) **Project Number— 12120114-O**
- b) **Project Title—Monitoring long-term changes in forage fish distribution, abundance, and body condition in Prince William Sound**
- c) **Principal Investigator— John Piatt and Mayumi Arimitsu**
- d) **Time Period Covered by the Report—02/01/12 to 01/31/13**
- e) **Date of Report— 03/01/13**
- f) **Project Website— We are actively working on a website for project outreach, but it was not yet ready at the time of this report.**
- g) **Summary of Work Performed—**
Our first objective was to identify robust indices for detecting change in forage fish populations over time and we began to work towards that goal before the first funding cycle began. Through numerous conversations with previous PI's, fisheries statisticians, and others familiar with the system, we determined that it would be useful to determine the age structure of the target forage

fish species that we will sample. In year one, we made progress on this front through collaboration with Vanesa von Biela, an otolith specialist at USGS.

During winter/spring 2012 we developed a protocol for ship-based surveys of forage fish in Prince William Sound (available on the ocean workspace). According to that plan, in July 2012 we conducted over 600 km of hydroacoustic surveys, and counted marine birds and mammals along the entire route. We ground-truthed acoustic signals and assessed forage species community composition with 31 mid-water trawl sets at 27 sites. At each trawl site we also measured oceanographic characteristics and sampled zooplankton. We also targeted Pacific sand lance with 20 beach seines at 12 sites. Overall, young of the year walleye pollock were the most numerous and frequently encountered species, followed by Pacific herring. Capelin, eulachon and euphausiids were collected more infrequently, and they occurred mainly in the cool, turbid waters of the fjords. We collected at least three age classes of sand lance in nearshore waters. Young of the year capelin were conspicuously absent during our survey, however we encountered ripe females in several fjords, suggesting that larval emergence had not occurred at the time of our surveys. This is in stark contrast to work we conducted on a separately funded study in College and Harriman Fjord in July 2010, when young of the year capelin dominated the catch. Over time we expect to detect changes in populations and better understand the mechanisms that drive the distribution, abundance, and age structure of forage species in Prince William Sound.

In winter/spring 2013 we continue to work on various tasks, including: hydroacoustic data processing, predator survey data analysis, fish otolith extraction and age determination, euphausiid and ichthyoplankton identification and enumeration, oceanography data processing, chlorophyll *a* extraction and fluorometry for calibration of in situ fluorometer, and general data management. We also established contracts for processing of zooplankton and nutrient samples. When all these data are fully processed and have undergone QA\QC, they will be uploaded to the ocean workspace with complete metadata. We anticipate this will occur prior to the next field sampling period in July 2013.

h) Summary of Future Work to be Performed—

We will proceed with planning and execution of field work in 2013. After conducting and evaluating the pilot 2012 field work, which involved only ship-based survey work for us, we have determined that it could increase our sampling efficiency if we were to incorporate aerial surveys into our overall sample design. The combination of ship-based and supplementary aerial survey sampling is potentially more effective for monitoring forage fish in Prince William Sound than either method alone. We are currently working a study plan revision that will incorporate limited aerial surveys (i.e., a small subset of historical surveys) in July to 1) aid in locating schools that can be subsequently sampled by boat surveys, and, 2) permit us to estimate abundance of forage fish (e.g., Pacific sand lance) schools that are closer to shore than we are able to sample with hydroacoustics. This work is not budgeted. To allow a pilot study, we will reduce boat sampling effort to incorporate a small pilot effort to conduct aerial surveys. If this proves to be successful, we would consider expanding the effort if it meets approval of the pelagic study group, and the EVOSTC. We are working with members of the herring survey to establish a protocol for aerial surveys. We are not attempting to repeat the level of sampling conducted historically by Evelyn Brown— which was a stand-alone effort to survey nearshore

forage fish throughout the sound— but rather to see whether a small aerial survey prior to boat surveys could yield high dividends in boat survey efficiency.

i) Coordination/ Collaboration—

We coordinated with members of the Herring Survey including: Mary Anne Bishop, Michelle Buckhorn, Scott Pegau, JJ Vollenweider, and Evelyn Brown. We trained Megan McKinzie (herring program personnel) on the deployment of the modified herring trawl that we use to ground truth hydroacoustic backscatter. We also were able to locate a large aggregation of adult herring, and notified JJ Vollenweider in the field so that she could obtain the samples necessary for their work. Our ship-based hydroacoustic surveys overlapped in timing with the aerial survey for forage fish in July. We also provided saffron cod samples to Tony Gharret (UAF) for genetics, and Ron Heinz (NMFS) for fatty acid analysis. We collected sculpin samples for taxonomic studies to Catherine Mecklenberg (Pt. Stephens Research) and Thaddaeus Buser (UAF).

j) Community Involvement/ TEK and Resource Management Applications—

This work will inform managers about changes in the prey base that may be responsible for predator population fluctuations. In addition to direct sampling of key forage species using state of the art instrumentation and net sampling methods that are typically cost prohibitive, we are also collecting a variety of habitat covariates that may influence the distribution and abundance of forage species over time. Taken as a whole, this research will help tease out the mechanisms for change in the ecosystem, whether that change is due to anthropogenic disturbance or natural variability.

k) Information Transfer—

- No publications have been produced during the reporting period.
- Presentations on forage fish component of the Gulf Watch Alaska program were conducted at the annual PI meeting in November 2012, and Alaska Marine Science Symposium in January 2013.
- We are still awaiting results from zooplankton, nutrients, and otolith samples, processing hydroacoustic and oceanographic data, and conducting QA/QC of the various geographic, physical and biological datasets. We will upload the complete database to the ocean workspace as soon as it's ready.

l) Budget—

From the beginning of the project, October 30, 2012 through January 31, 2013, we spent \$123.1K on personnel, \$14.2K on travel, \$17.7K on contracts, \$31.6K on commodities, and 15.1K on equipment. With the 9% overhead on proposed funds, or \$17.3K, the total spent on this project was \$218.9K.

We spent \$8.95K more than we originally proposed, which included \$2.7K more in travel, \$3.1K more in contracts, \$11.6K more in commodities, and \$8.4K less in equipment. Some of the discrepancy is related to project spending before the project funding began, unforeseen costs associated with equipment repair, and software price difference from original quote (e.g., hydroacoustic processing software was \$4K more than we anticipated when we estimated costs in the proposal because the original quote had expired prior to purchase). Additionally, the

hydroacoustic processing software was listed as equipment in the proposal, when it should have been listed as a commodity.

The USGS-Alaska Science Center spent nearly \$9000 more than originally proposed, which brings the USGS in-kind contribution for year one of the study to \$347,932.

**EXXON VALDEZ OIL SPILL TRUSTEE COUNCIL
ANNUAL PROGRAM REPORT YEAR 1**

Budget Category:	Revised Year 1	Actual Year 1	TOTAL Difference
Personnel	\$123,097.0	123,097	0
Travel	\$11,396.0	11,396	0
Contractual	\$14,600.0	14,600	0
Commodities	\$20,000.0	28,381	(8,381)
Equipment	\$23,465.0	15,084	8,381
Other	0	0	0
Indirect Costs (<i>will vary by proposer</i>)	0	0	0
SUBTOTAL	192,558	192,558	0
General Administration (9% of subtotal)	17,300	17,300	0
PROJECT TOTAL	209,858	209,858	0
Other Resources (Cost Share Funds)	\$0	\$8,993	\$8,993

COMMENTS: Year One of this project spent \$8.99K more than we originally proposed, which included \$2.7K more in travel, \$3.1K more in contracts, \$11.6K more in commodities, and \$8.4K less in equipment. Some of the discrepancy is related to project spending before the project funding began, unforeseen costs associated with equipment repair, and software price difference from original quote (e.g., hydroacoustic processing software was \$4K more than we anticipated when we estimated costs in the proposal because the original quote had expired prior to purchase). Additionally, the hydroacoustic processing software was listed as equipment in the proposal, when it should have been listed as a commodity. This cost overrun was absorbed by the agency.

FY12

**Program Title: 12120114-O, Forage Fish
Distribution, Abundance, and Body Condition
Team Leader: John Piatt /Yumi Arimitsu
Agency: USGS**

SUMMARY

March 1, 2013

Long-Term Monitoring Year One, Budget vs Actual 2012-13

Principal Investigators and Institution	EVOS Project Number	Activity - short project title	Yr 1 Budget	Yr 1 Actual	Balance Available
		Environmental Drivers			
Campbell, PWSSC	12120114-E	Prince William Sound Oceanographic	218,400.0	215,661.0	2,739.0
Weingartner, UAF	12120114-P	GAK1 (Gulf of Alaska) Mooring	100454.0	0.0	100454.0
Hopcroft, UAF	12120114-J	Seward Line	90,040.0	72,811.0	17,229.0
Doroff, ADFG; and Holderied, NOAA	12120114-G	Lower Cook Inlet Oceanographic	176,000.0	105,471.3	70,528.7
Batten, SAHFOS	12120114-A	Continuous plankton recorder (CPR)	0.0	0.0	0.0
		Environmental Drivers Total	584,894.0	393,943.3	190,950.7
		Pelagic Monitoring			
Matkin, NGOS	12120114-M	Killer whale monitoring	6,600.0	0.0	6,600.0
Moran, NOAA ; and Straley, UAS	12120114-N	Humpback whale monitoring	116,900.0	156,000.0	-39,100.0
Piatt, USGS	12120114-O	Forage fish	192,558.0	192,558.0	0.0
Irons, USGS ; and Kuletz, USFWS	12120114-K	Nearshore marine birds surveys	189,445.0	191,294.3	-1,849.3
Coletti, NPS	12120114-F	Bird synthesis	30,000.0	0.0	30,000.0
Bishop, PWSSC	12120114-C	Seabird monitoring in late fall/winter	47,400.0	0.0	47,400.0
		Pelagic Monitoring Total	582,903.0	539,852.3	43,050.7
		Benthic Monitoring			
Ballachey, USGS ; and Dean, CRA, Inc .	12120114-R	Nearshore benthic PWS (sea otters, seagrass/kelp, intertidal invertebrates/algae, benthic voraging seabirds)	259,125.0	148,788.6	110,336.4
Konar and Iken, UAF	12120114-L	Kachemak Bay Intertidal	44,100.0	7,784.0	36,316.0
		Benthic Monitoring Total	303,225.0	156,572.6	146,652.4
		Coordination, Data Management, Outreach and Administration			
Holderied, NOAA	12120114-H	Science Synthesis/ Coordination	113,300.0	94,908.0	18,392.0
McCammon, AOOS/Bochenek, Axiom	12120114-D	Data Management	174,981.0	156,375.0	18,606.0
Hollmen, ASLC	12120114-I	Ecological modeling	76,260.0	10,336.0	65,924.0
Bird, PWSSC / McCammon, AOOS	12120114-B	Administration, science review and LTM mtg logistics, Outreach & Communications	241,600.0	139,953.0	101,647.0
		Coordination, Data Management, Outreach and Administration Total	606,141.0	401,572.0	204,569.0
M. Jones, NCEAS	12120120	Collaborative Data Management and Holistic Synthesis of Impacts and Recovery Status Associated with the Exxon Valdez Oil Spill	382,409.0	185,948.0	196,461.0
		Overall Program Total Cost w/o Lingering Oil	2,459,572.0	1,677,888.2	781,683.8

Lingering Oil Monitoring					
Carls, NOAA	12120114-S	1 - Extending tracking oil composition and weathering in PWS	18,000.0	18,000.0	0.0
Ballachey, NOAA , & Esler, Simon Fraser Univ. & Pacific Wildlife Fdtn	12120114-Q	2a & b - Evaluate chronic exposure of sea otters and harlequin ducks in PWS	187,400.0	108,592.3	78,807.7
Lingering Oil Monitoring Total			205,400.0	126,592.3	78,807.7
Overall Program Total Cost			2,664,972.0	1,804,480.5	860,491.5